



**NEC**

NDA-31958

Issue 2.0

# ***UNIVERGE<sup>®</sup> SV9100***

---

## ***DT930 (ITK-24CG) USER GUIDE***

**NEC Enterprise Communication Technologies, Inc.  
December, 2019**



NEC Enterprise Communication Technologies, Inc. reserves the right to change the specifications, functions, or features at any time without notice.

NEC Enterprise Communication Technologies, Inc. has prepared this document for use by its employees and customers. The information contained herein is the property of NEC Enterprise Communication Technologies, Inc. and shall not be reproduced without prior written approval of NEC Enterprise Communication Technologies, Inc.

*D<sup>term</sup>*, NEAX and UNIVERGE are registered trademarks of NEC Corporation. Windows is a registered trademark of Microsoft Corporation.

Copyright 2019

**NEC Enterprise Communication Technologies, Inc.  
3929 W. John Carpenter Freeway  
Irving, TX 75063-9406**





# TABLE OF CONTENTS

---

## 1. INTRODUCTION

<b>General</b> .....	<b>1</b>
<b>Face Layout</b> .....	<b>2</b>
<b>Technical Specifications</b> .....	<b>3</b>
<b>Keys And Parts</b> .....	<b>4</b>
<b>Installation Procedure</b> .....	<b>6</b>
Attaching Handset .....	6
Connecting the Line Cord.....	6
Attaching the Directory Card .....	7
Attaching or Removing Faceplate and DESI Printer Sheet.....	7
Removing Faceplate and DESI Printer Sheet.....	7
Attaching Faceplate and DESI Printer Sheet.....	8
Removing and Replacing the Numbered Keypad Panel (BS(F)-K/BS(S)-K/ BS(ACD)-K) .....	8
Removing/Installing the Numbered Keypad Panel.....	9
Installing the Numbered Keypad Panel.....	9
Applying Power to the Telephone.....	9
Adjusting Angle of Tilt Legs .....	10
Connecting LAN Cable .....	10
Wall Mounting the Telephone.....	11
Adjusting the Hanger Hook .....	11
Mounting the Telephone to the Wall Receptacle .....	11
Removing the Wall Mounted Telephone from the Wall Mounted Base Plate.....	12
Wall Mounting the Base on the Wall Plate .....	13

# TABLE OF CONTENTS

---

## 2. OUTLINE – CLASSIC

<b>Phone Start Up and Menu Screen .....</b>	<b>15</b>
Starting Up The Phone (without a home URL registered) .....	15
Starting Up The Phone (with a home URL registered) .....	16
Menu Screen .....	17
Starting Up XML Application.....	19
Starting from Menu Button .....	19
<b>Shortcut Menu .....</b>	<b>19</b>
Status Icons.....	20
<b>Soft Keys .....</b>	<b>20</b>
How to Use Soft Keys.....	21
<b>Multi-Window .....</b>	<b>22</b>
Switching XML Applications .....	22
Switching Local Applications .....	24
Launching the Fifth Application .....	25
Icon Display at XML Application Update .....	26
<b>Pop-up Windows .....</b>	<b>26</b>
Launching a Pop-Up Window .....	27
Exiting a Pop-Up Window.....	27

## 3. TERMINAL SETUP – CLASSIC

<b>Setup With Up/Down Key .....</b>	<b>29</b>
Adjust Handset Receiver Volume.....	29
Adjust Speaker Volume .....	29
Adjust Ringer Tone.....	29

## TABLE OF CONTENTS

---

<b>Setup With Feature Key</b> .....	<b>29</b>
Microphone On/Off .....	29
<b>Setup with Menu Key</b> .....	<b>30</b>
Enable/Disable Off-Hook Ringing .....	30
Set Ringing of Headset.....	31
Set Ringer Tone .....	32
Set Illumination Pattern for Call Indication Lamp.....	35
Enable/Disable RTP Alarm.....	37
Enable/Disable DTMF Tone .....	38
Set Key Touch Tone.....	40
Set Music on Hold .....	41
Set Clock Format.....	42
Enable/Disable Volume Level Display.....	44
Set Screen Saver .....	46
Set Brightness of Backlight.....	47
Change Character Size .....	49
Set a Language .....	50
Set Wallpaper .....	51
Set Character Font Color.....	53
Table of Font Color .....	55
Set Turn Off Display .....	56
Set Backlight Fade Control.....	58
Change Password .....	60
Set Usability.....	62
Reset Telephone Settings .....	63
Download a File.....	64

## TABLE OF CONTENTS

---

Backup Personal Settings .....	71
Restore Personal Settings.....	77
<b>4. OUTLINE – PORTAL</b>	
<b>Telephone Startup .....</b>	<b>83</b>
Favorite Screen .....	83
Information Area.....	83
Status Icon .....	84
Ext No./Ext Name .....	84
Clock and Calender .....	84
Local Soft Key Display.....	85
<b>Call Screen .....</b>	<b>85</b>
System Information Area .....	85
System Soft Key Area .....	85
Local Soft Key Area.....	86
To Start Call Screen .....	86
To Close Call Screen Automatically .....	86
<b>Screen When the Phone Starts .....</b>	<b>86</b>
To Set the Home Screen .....	86
Register a Home URL .....	87
<b>To Start Up the Phone .....</b>	<b>87</b>
<b>5. TERMINAL SETUP – PORTAL</b>	
<b>Terminal Setup .....</b>	<b>89</b>

## TABLE OF CONTENTS

---

<b>Adjusting Volume</b> .....	<b>89</b>
To Adjust Handset Receiver Volume.....	89
To Adjust Speaker Volume.....	89
To Adjust Ringer Tone.....	89
<b>Setup With Feature Key</b> .....	<b>89</b>
Microphone On/Off .....	89
<b>Setup with Menu Key</b> .....	<b>90</b>
Enable/Disable Off-Hook Ringing.....	90
To Set Ringing of Headset .....	90
Set Ringer Tone .....	91
To Set Illumination Pattern for Call Indicator Lamp .....	92
To Enable/Disable RTP Alarm.....	92
To Enable/Disable DTMF Tone .....	93
To Set Key Touch Tone.....	93
To Set Music on Hold .....	93
To Set Time Format.....	94
To Enable/Disable Volume Level Display.....	94
To Set Screen Saver .....	94
To Set Brightness of LCD Backlight .....	95
Set a Language .....	95
To Set Turn Off Display .....	95
To Enable/Disable LCD Backlight Fade Control.....	96
To Change GUI Mode .....	96
Portal Mode .....	97
To Change Theme.....	97
To Change Password.....	97

## TABLE OF CONTENTS

---

To Set Usability .....	98
Reset Telephone Settings .....	98
To Download a File.....	99
<b>Backup or Restore the Settings Data of the Terminal .....</b>	<b>102</b>
To Backup the Settings Data of the Terminal.....	102
To Restore the Settings Data of the Terminal .....	104
<b>6. FEATURE OPERATION</b>	
<b>Login/Logout .....</b>	<b>107</b>
To Login .....	107
To Logout .....	107
<b>Making a Call .....</b>	<b>109</b>
To Make an External Call .....	109
To Make an Internal Call .....	109
<b>Answering a Call .....</b>	<b>109</b>
To Answer an External Call.....	109
To Answer an Internal Call .....	109
<b>Holding a Call (Using Call Hold) .....</b>	<b>109</b>
To Hold .....	110
To Retrieve the Held Call .....	110
If Unanswered .....	110
<b>Holding a Call (Using Exclusive Call Hold) .....</b>	<b>110</b>
To Hold .....	110
To Retrieve the Held Call .....	110
If Unanswered .....	111

## TABLE OF CONTENTS

---

<b>Transfer a Call</b> .....	<b>111</b>
To Transfer a Call (With Announcement) .....	111
Initiate Transfer (By Ex.200) .....	111
Answer to a Transferred Call (By Ex.210).....	111
To Transfer a Call (Without Announcement) .....	111
Initiate Transfer (By Ex.200) .....	111
Answer A Transferred Call (By Ex.210) .....	112
<b>One-Touch Speed Calling Keys</b> .....	<b>112</b>
To Program.....	112
To Verify .....	112
To Make a Call .....	113
<b>Speed Dialing – Station/Group</b> .....	<b>113</b>
Set Speed Dial Bin .....	113
Make a Call.....	113
<b>Last Number Redial</b> .....	<b>113</b>
<b>Redial</b> .....	<b>114</b>
Delete a Call Record from the Outgoing Call History .....	114
Delete All Records from the Outgoing Call History.....	114
<b>Voice Call</b> .....	<b>114</b>
Using Soft Key.....	114
<b>Three-Party Conference</b> .....	<b>115</b>
<b>Voice Mail System</b> .....	<b>115</b>
<b>DND (Do Not Disturb)</b> .....	<b>115</b>
To Set DND .....	115
To Cancel .....	116

# TABLE OF CONTENTS

---

<b>How to Input Characters</b> .....	<b>116</b>
Character Entry Mode .....	116
Character Code List.....	118
Character Entry Method .....	124
<b>Security Mode</b> .....	<b>124</b>
<b>Phonebook</b> .....	<b>125</b>
System Phonebook .....	125
Available Characters in Local Phonebook .....	125
<b>7. FAVORITE SCREEN OPERATION</b>	
<b>Favorite Screen</b> .....	<b>128</b>
How to Select a Shortcut .....	129
Shortcut Icon .....	129
Shortcut Name.....	129
<b>To Register a Shortcut</b> .....	<b>130</b>
<b>To Use the Shortcut</b> .....	<b>131</b>
<b>To Edit the Shortcut</b> .....	<b>133</b>
<b>To Delete Shortcut</b> .....	<b>134</b>
From a Registered Shortcut .....	134
From User Settings.....	135
<b>To Change Shortcut Display</b> .....	<b>136</b>
<b>8. DIRECTORY OPERATION</b>	
<b>Add New Data</b> .....	<b>137</b>
<b>Find Registered Data</b> .....	<b>138</b>



## TABLE OF CONTENTS

---

Make a Call from Directory .....	139
To Set Prefix .....	139
Delete All Data .....	140
Delete Specific Directory Data .....	140
<b>9. CALL HISTORY OPERATION</b>	
To View Call History .....	143
To Make a Call from Call History .....	143
Store Call History data to Speed Dial .....	144
To Delete Call History Data .....	144
<b>Appendix A. Menu List</b>	
Menu List: DT930 (ITK-24CG-1).....	145
<b>Appendix B. Web Programming</b>	
Login .....	155
Logout .....	158
How to Operate .....	158
<b>Appendix C. To Upload an Image</b>	
Image Upload Procedure .....	161
PC Connection and Setting .....	161
PC Requirements.....	161

## TABLE OF CONTENTS

---

Connection .....	161
Maximum User Program PC Connection .....	162
LAN Setting .....	162
User Programming Setup .....	162
To Upload an Image .....	164

# 1. INTRODUCTION

---

## General

This guide explains how to operate DT930 Series under the following headings.

### **CHAPTER 1 INTRODUCTION**

Explains the configuration of this guide and contains the following information.

- Face layout of DT Series
- Keys and Parts of DT Series
- Icon Display
- Menu List

### **CHAPTER 2 TERMINAL SETUP – CLASSIC**

Explains the operating procedures for terminal settings (Classic Mode) of the DT Series.

### **CHAPTER 3 TERMINAL SETUP – PORTAL**

Explains the operating procedures for terminal settings (Portal Mode) of the DT Series.

### **CHAPTER 4 BASIC OPERATION**

Explains the basic operation of DT Series.

### **CHAPTER 5 DIRECTORY OPERATION**

Explains operating procedures for Directory function.

### **CHAPTER 6 CALL HISTORY OPERATION**

Explains operating procedures for Call History.

## Face Layout

DT930 (ITK-24CG-1)

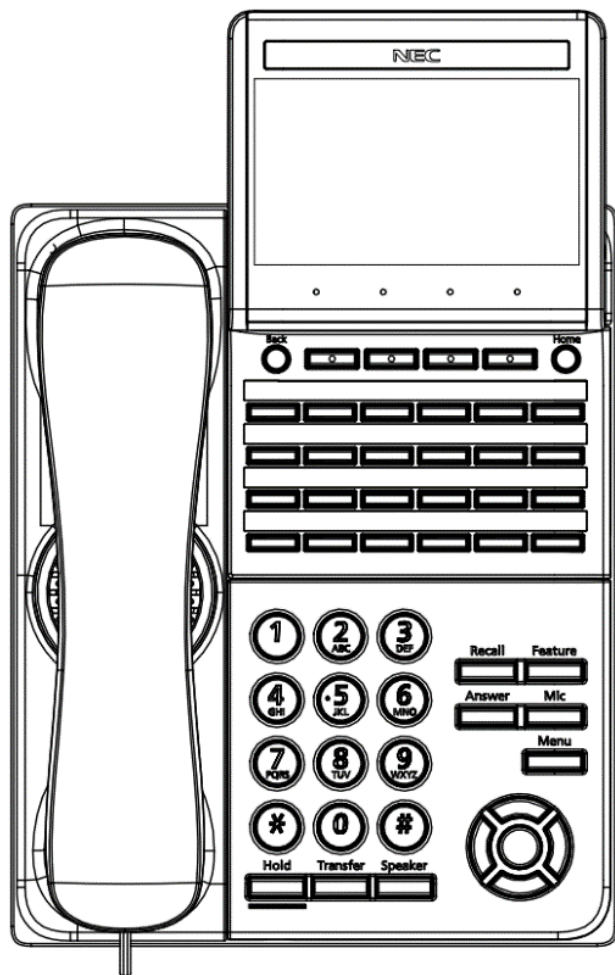

## Technical Specifications

Item	ITK-24CG-1
Display LCD	4.3 inch Color (16777216 colors) TFT, with Backlight
LCD Color	Color (16.77million color)
Programmable Key	24 Keys
Fixed Feature Key	13 (Hold, Transfer, Speaker, Recall, Feature, Answer, Mic, Menu, 4 Cursor key, Enter)
Backlight	LCD and digit key (lit for 10 seconds when operating)
Soft Key	4 Keys
Directory	1000 Records
Call History	Outgoing Call: 50 records and Incoming Call: 50 records
XML Browser	Available
Handsfree	Standard equipment (Full-duplex)), Wide-band
Headset	Available (HW510 (A10) / HW251N (A10) / WT100 (APN-91) / Voyager Legend CS (APN-91) / W710(APD-80) / W710(APN-91)
LAN Interface	2-port, 10BASE-T/100BASE-TX/1000BASE-T, Full-duplex/Half-duplex, Auto Negotiation/Fixed (Except 1000BASE-T)
Voice CODEC	G.711 ( $\mu$ -law, A-law), G.729a, G.722
IP Address Setting	Sets via DHCP server/Sets Statically
QoS	ToS (IP Precedence, Diffserv)
VLAN	Tag VLAN (IEEE802.1Q/p), LLDP-MED, DHCP
Security	IEEE802.1x authentication (EAP-MD5, EAP-TLS), IEEE802.1x authentication support (EAPoL Forwarding) on the PC port via switch at a high hierarchy level, SIP&RTP Encryption, HTTPS (Web Programming/Download), VPN (L2TP/IPsec (IPv4)
Power Supply	Central Power Supply = IEEE802.3at Type1 (IEEE802.3af compatible) Local Power Supply = AC Adapter (Optional)
Power Consumption	Max: Approximately 4.2W, Standby: Approximately 2.2W (without optional connection)
Download	Boot and Program / Config /Ringing Tone / Music on Hold / Wallpaper / Voice Confirmation Tone
Adapter and Accessory (Optional)	Ancillary Device Adapter (ADA) Wall Mount unit (WM) / Line Key Unit (8LK) / Directory Card /60-button DSS / Numbered Keypad
Terminal Color	Black / White
Dimension (WxDxH)	181(W) x 254(D) x 152(H) [mm] / 7.12(W) x 10(D) x 5.98 (H) [in]
Weight	1.0 Kg / 2.20 lbs
Environmental	Temperature range = 0° to 40°C / 32°F to 104°F (Ambient temperature range = -20°C to 60°C / 68°F to 140°F) Humidity = 10% to 90% RH (non-condensing)

## Keys And Parts

### DT930

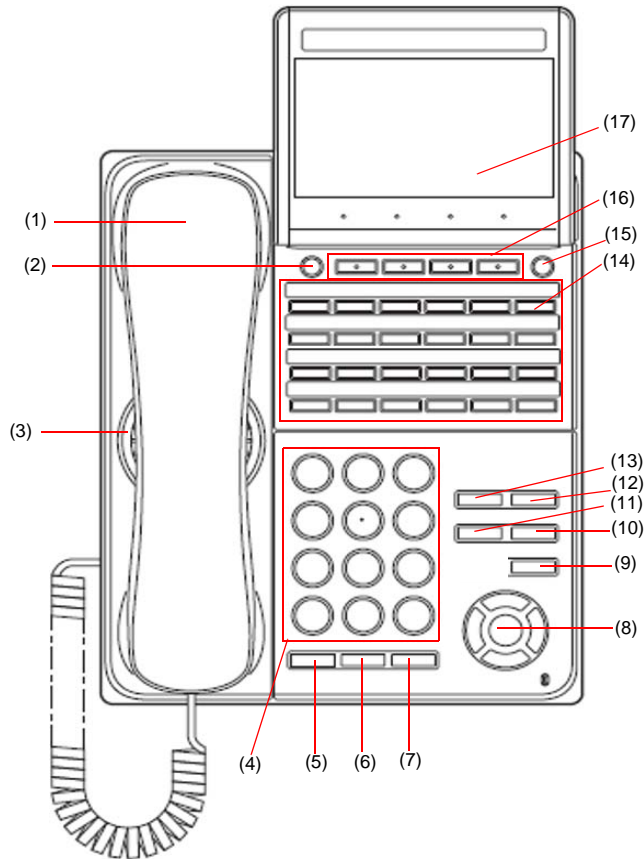

- (1) Handset  
Used for sending/receiving voice.
- (2) Back Button  
Classic Mode: To exit the Menu or Help mode and go back to the time display.  
Portal Mode: Return to the previous screen.
- (3) Speaker  
Used when originating a handsfree call.
- (4) Dial Keypad  
Dial the called party number or feature access code.
- (5) Hold Key  
To place an internal or external call on hold.
- (6) Transfer Key  
Allows the station user to transfer established calls to another station, without attendant assistance.
- (7) Speaker Key  
To control the built-in speaker which can be used for:  
Hands-Free dialing/monitoring.  
LED on key lights when the key is active.  
\* All standard IP versions include support for full duplex hands-free mode. All TDM and IP enabled versions are half duplex hands-free mode.
- (8) Cursor Key  
By using this key, you can access various features with a simple operation.

## Details on Cursor Key

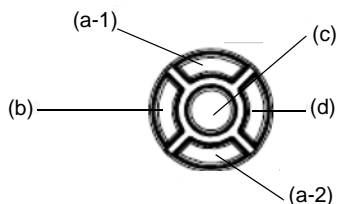

- (a-1) Volume (UP) key (Four-way scroll **up** key)
- (b) Redial key\* (Four-way scroll **left** key)
- (c) Enter key
- (d) Directory key\* (Four-way scroll **right** key)
- (a-2) Volume (DOWN) key (Four-way scroll **down** key)

\* When in Classic Mode.

### (a) Up/Down

(∨ DOWN ^ UP)

Used to adjust speaker/receiver volume, and ringer volume.

- Speaker/Receiver Volume:  
Press (∨) or (^) key during conversation.
- Ringer Volume:  
Press (∨) or (^) key during ringing.

### (b) Redial/CID Scroll

(Last Number Call, Speed Calling-Station/Group - Classic Mode Display)

Press key once to activate redial feature.

Press redial and scroll through numbers that have been dialed.

When the desired number is displayed, press the # key to activate dialing.

Press key twice to activate the CID scroll feature. Press key twice and scroll through numbers that have been received.

When the desired number is displayed go off hook to activate dialing.

### (c) Enter (Classic Mode Display)

This accesses a shortcut menu for frequently-used features. Use this key to display the shortcut menu and determine the selected item in the menu.

Also, this key is used as cursor-movement key on the local menu of the telephone.

### (d) Directory (Classic Mode Display)

Pressing this key opens Directory menu. For details on Directory service, see [8.DIRECTORY OPERATION](#).

	<b>Up</b>	Move the highlighted area one line up the screen.
	<b>Down</b>	Move the highlighted area one line down the screen.
	<b>Left</b>	Go back to the previous screen.
	<b>Right</b>	Go to the screen which corresponds to the highlighted menu item.
	<b>Enter</b>	Go to the screen which corresponds to the highlighted menu item.

### (9) Menu Key

To access the local menu.

### (10) Mic Key

To respond handsfree. LED lights during speakerphone operation.

- (11) **Answer Key**  
When LED on this key is lit, press this key to answer a waiting call.
- (12) **Feature Key**  
To activate features such as terminal setup, and to program One-Touch Speed Dial Keys.
- (13) **Recall Key**  
To finish a call and hear the dial tone.
- (14) **Programmable Keys**  
These keys can be programmed as Flexible line key/Programmable feature key by System Administrator.
- (15) **Home Key**  
Classic Mode: To display explanations of the softkeys on the LCD.  
  
Portal Mode: Returns to the Home screen (Favorite or Call screen) specified in the system/terminal menu settings.  
  
If a Home URL has been set. press this button to return to the Home URL.



*In Classic mode, not all contents are displayed. Contact the System Administrator for details.*

- (16) **Softkeys**  
Any feature shown at the bottom of the LCD is available. The appropriate feature key is displayed on the screen according to the call handling process.
- (17) **LCD**  
4.3 inch color display with backlight.

## Installation Procedure



*The images used in the section are for illustrative purposes. Some of the images might not be images of DT930 telephones.*

### Attaching Handset

- (1) Install the modular plug (attached to the curl cord of the handset) into the handset connector at the back of terminal. Push until it snaps into place.
- (2) Lead the Handset cable through the applicable groove.

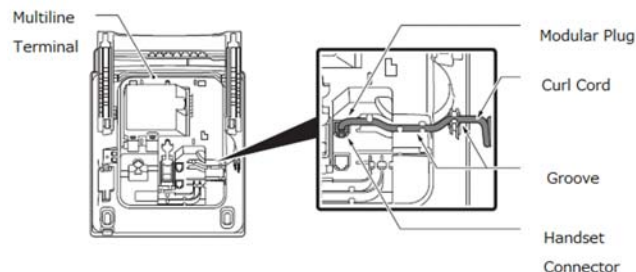

### Connecting the Line Cord

#### Line Cord Connection DT930

- (1) Install the modular plug of the line cord into the Line Connector at the back of terminal. Push until it snaps into place.



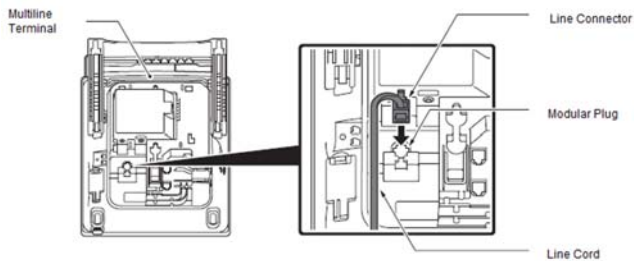

- (2) Install the Line Cord in the groove as shown in the following diagram.

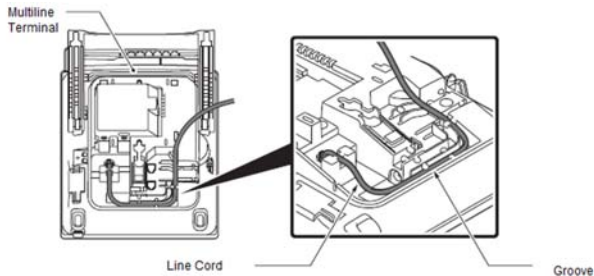

- (3) Turn the terminal over and place it so the line cord can be passed through the groove between the tilt legs.

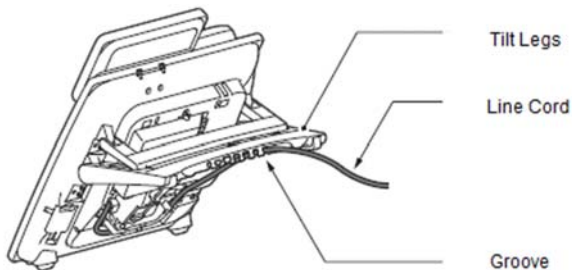

## Attaching the Directory Card

A directory card can be attached to DT930 multiline telephone. The directory card can be used to record often dialed numbers or other important information.

- (1) Insert the holder into the holder socket on the back of the multiline telephone.
- (2) A protective sheet is attached to the surface of the cover to prevent scratches. Peel off before attaching to the holder.
- (3) Insert the Directory Card into the cover and attach it to the holder.

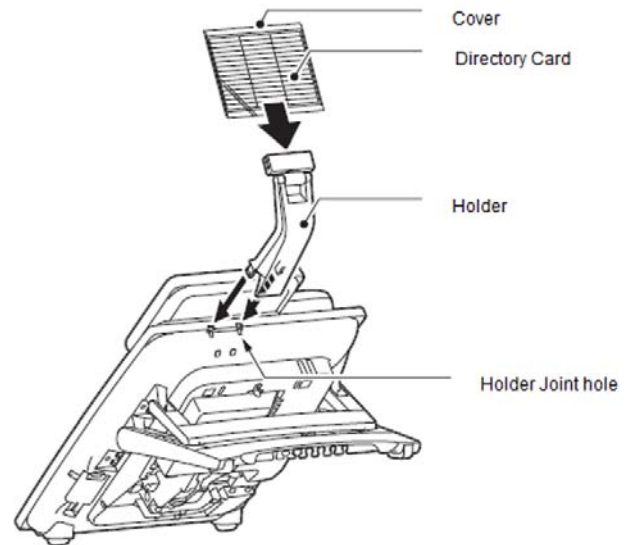

## Attaching or Removing Faceplate and DESI Printer Sheet

### Removing Faceplate and DESI Printer Sheet

Remove DESI printer sheet using the following:

- (1) Use the small notch at the lower right corner of the terminal to lift the faceplate up.
- (2) Remove the faceplate.
- (3) Remove the DESI Printer Sheet.

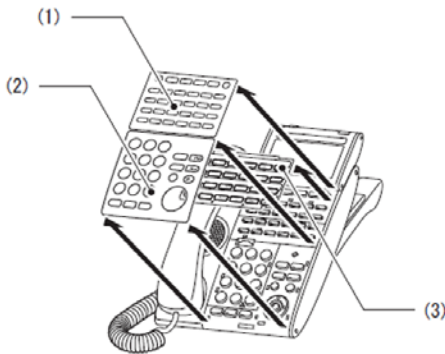

- (1) Line Key Panel
- (2) Numbered Keypad Panel
- (3) DESI Printer Sheet

### Attaching Faceplate and DESI Printer Sheet

- (1) After replacing the DESI Printer Sheet on the terminal, attach the faceplate.
- (2) At each corner, press the locking pin back into place (see the diagram above).



*Ensure the faceplate is attached securely. If it is loose, the terminal may not operate correctly if a key is being pressed by the faceplate.*

### Removing and Replacing the Numbered Keypad Panel (BS(F)-K/BS(S)-K/BS(ACD)-K)

The Numbered Keypad (in black or white), is commonly delivered in the Business/Standard Layout configuration and can be easily removed and replaced.

#### BS(F)-K(WH/BK) KIT

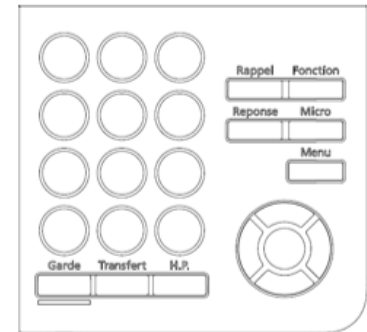

#### BS(S)-K(WH/BK) KIT

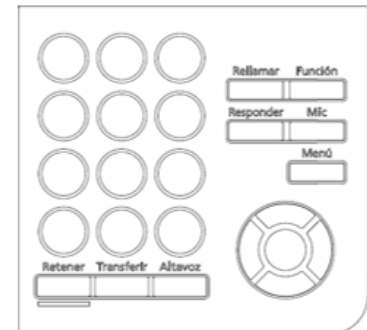

#### BS(ACD)-K(WH/BK) KIT

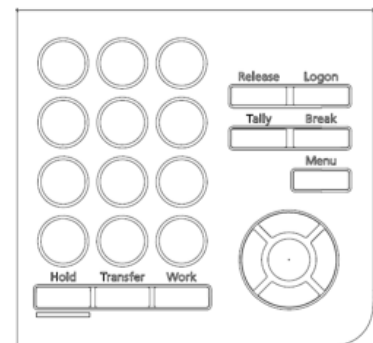

## Removing/Installing the Numbered Keypad Panel.

- (1) Lift up on the keypad panel as shown in the diagram to remove it.

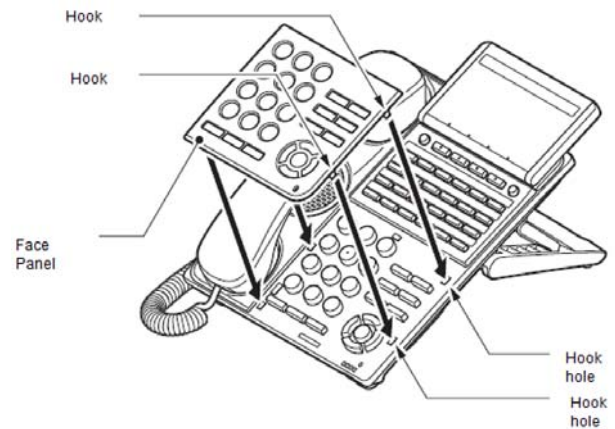
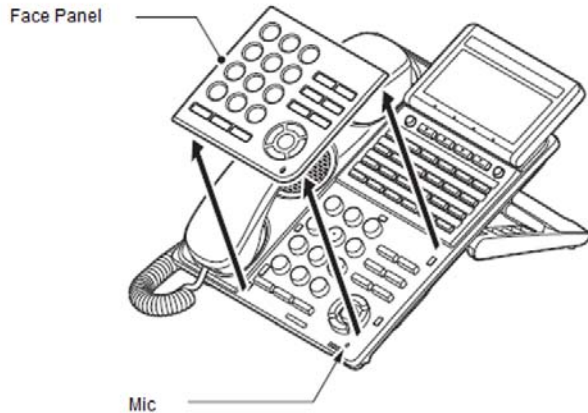

*To prevent possible damage to the Numbered Keypad or the ITK multiline terminal during installation or removal, disconnect the line cord/ LAN cable and the AC/DC adapter from the ITK multiline telephone.*

## Installing the Numbered Keypad Panel

Align the four hooks on the face panel to the holes on front of the multiline telephone and press until it clicks into position.

## Applying Power to the Telephone

The DT900 series terminals support two different power sources:

- In-Line Power/PoE (Power over Ethernet)  
In-Line Power (sometimes called Power Over Ethernet) is a LAN technology that allows standard 10 Base-T/100 Base-TX data cables to pass electrical current from a power source to a requesting end device.
- ITK Terminals  
An AC-Z Unit is required if using local power.



*Insert the AC adapter plug into the connector for AC adapter on the back of the telephone before connecting the AC power plug into the power outlet.*

## Adjusting Angle of Tilt Legs

The height can be adjusted by moving the legs, which are attached to the bottom of the telephone.

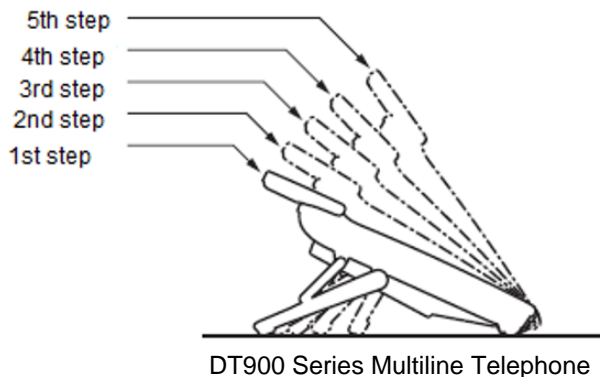

- (1) Turn the telephone over (key side down).
- (2) Adjust the legs to the desired height (upward to raise the height and downward to lower the height).

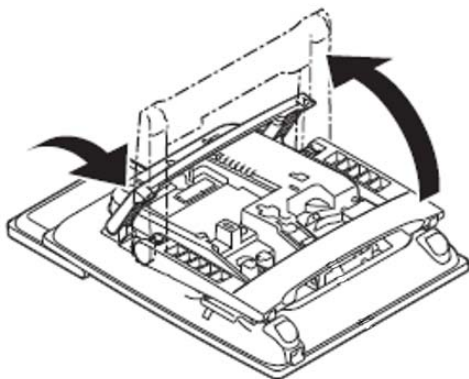

- (3) Turn the telephone over (key side up).

## Connecting LAN Cable

Confirm the location of AC adapter and the LAN connector at the back of the multiline telephone. Then connect the multiline telephone using the following steps.

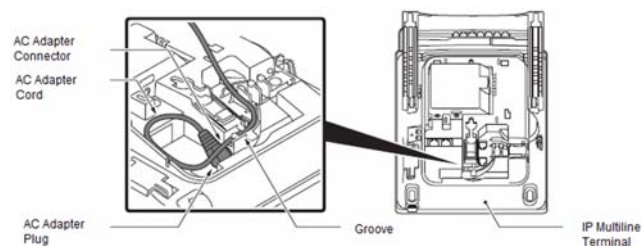

- (1) Connect the LAN Network cable to the LAN (=) connector.
- (2) The IP telephone has a switching HUB to connect a PC to the LAN Network. Connect the 10 Base-T/100 Base-TX/1000 Base-T straight cable used for this connection to the PC(x) connector and to the PC.

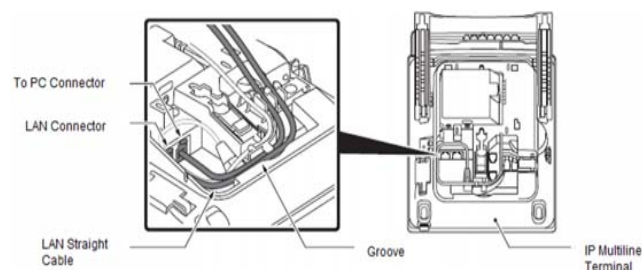

*When using the PC port with a local power supply, depending on the LAN cable connector housing, the LAN cable connector may not fit. Remove the outer plastic covering from the LAN cable connector, or use the LAN cable with a thin connector.*

## Wall Mounting the Telephone

You can wall mount a DT930 telephone. The WM-L UNIT is required when optional adapters are installed on the telephone.

### Adjusting the Hanger Hook

- (1) Remove the hook from the unit.
- (2) Turn the hook with the tab toward the top.
- (3) Slide the hook until it glides into position forming the hanger hook for the handset.

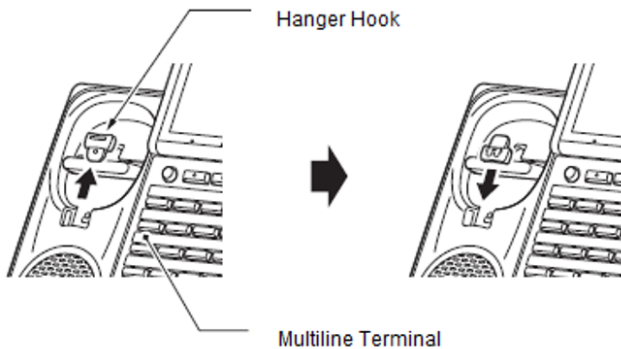

## Mounting the Telephone to the Wall Receptacle

- (1) Plug line cord into the wall receptacle. Leave about eight inches of cord and bundle the rest as shown in the following diagram.

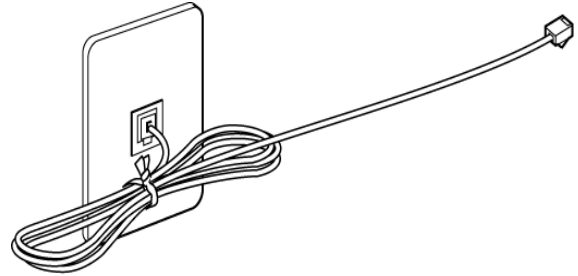

- (2) Ensure the tilt legs are in the flat (unused) position.
- (3) Plug the line cord into the multiline telephone as illustrated below.

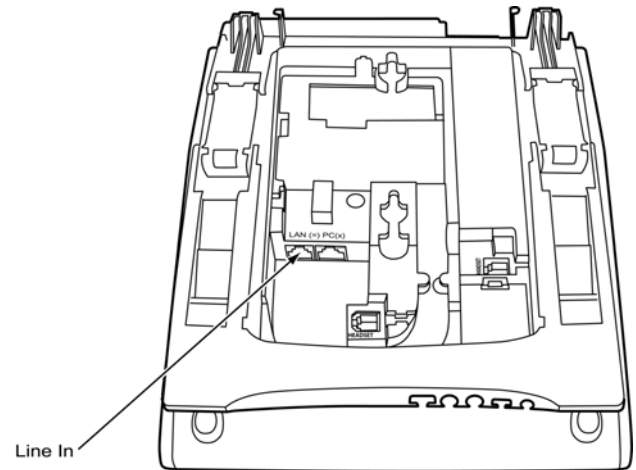

- (4) Align the two holes on the back of the multiline telephone with the two screws on the wall plate and slide downward as shown in the following diagram.

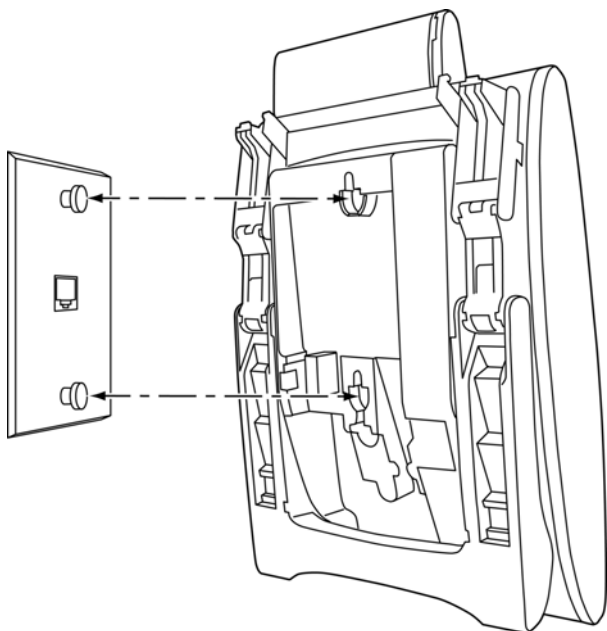

- (5) Push the spare line cord behind the telephone.

### Removing the Wall Mounted Telephone from the Wall Mounted Base Plate

- (1) Push up on the telephone until it comes loose.

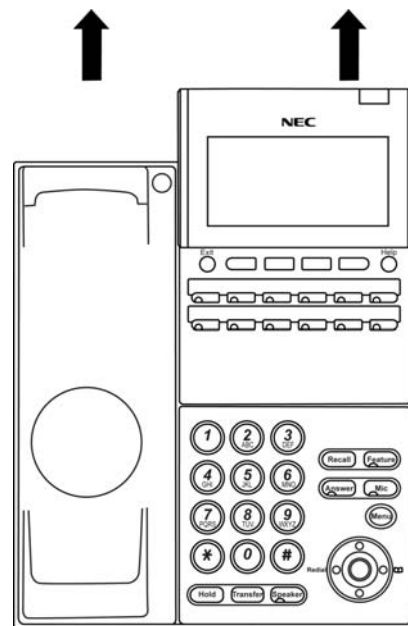

## Wall Mounting the Base on the Wall Plate

- (1) Locate the screw holes on the base and hang the cover over the screws on the wall plate as shown in the following diagram.

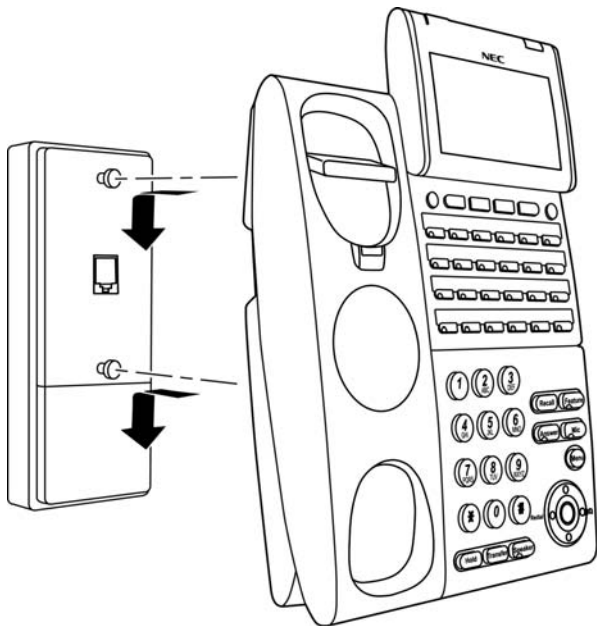

- (2) Hang the telephone on the base.

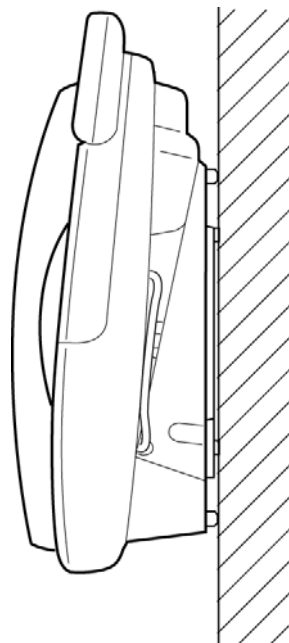

*Because of variation in wall plates, this method is not recommended.*

This page is for your notes.



## 2. OUTLINE – CLASSIC

### Phone Start Up and Menu Screen

The screen that is displayed right after starting up the phone depends on whether you start up the phone by using an XML application without its home URL registered or with its home URL registered. This section provides sample screen displays for both cases, and explains how to start up the menu screen.

#### TIP

##### HOME URL:

A home URL is the address information of the application that is to be accessed first after the phone is started. Home URL registration is performed at installation. For details, contact the System Administrator.

#### TIP

##### PORTAL SCREEN:

A **Portal** screen is the home (entrance) screen of the phone. When you use multiple XML applications, the URL that is registered as the home URL is the **Portal** screen: this is where other XML applications can be accessed.  
When a home URL is not registered, the default home screen of the phone is the **Portal** screen.

### Starting Up The Phone (without a home URL registered)

- **Desktop** screen is displayed after the phone is started.

#### TIP

The Desktop screen that is displayed on your phone varies depending on the configuration setting. For details, contact the System Administrator.

### Desktop Screen (ITK-24CG-1)



Service/Icon	Description
Status Icon	The LCD of DT930 displays icons which provide notification when events (such as missed call and voice mail) occur. For details of status icons, see <a href="#">Status Icons</a> .
LCD 4-line display	Displays LCD information sent from the system.

- Press the menu to display the menu screen.

The screen displayed as the **Portal** icon is the **Desktop** screen.



### Menu Screen (ITK-24CG-1)

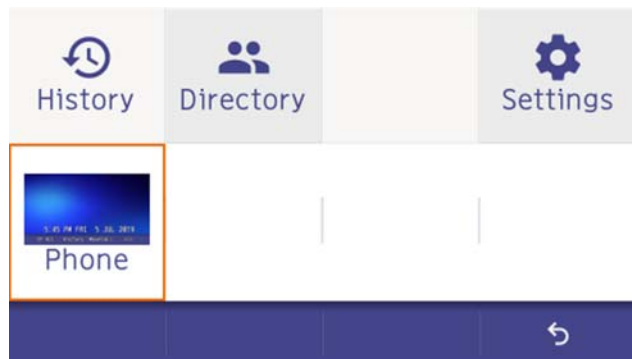

### Starting Up The Phone (with a home URL registered)

The phone automatically accesses the home URL, and displays the received XML application as the Portal screen.



*The following XML application screen and the Portal screen icon are samples. The actual screen that is displayed on your phone may vary depending on the application used.*



- Press the menu button to display the menu screen.

Menu



The screen displayed as the **Portal** icon is the screen of the XML application that is registered as the home URL.

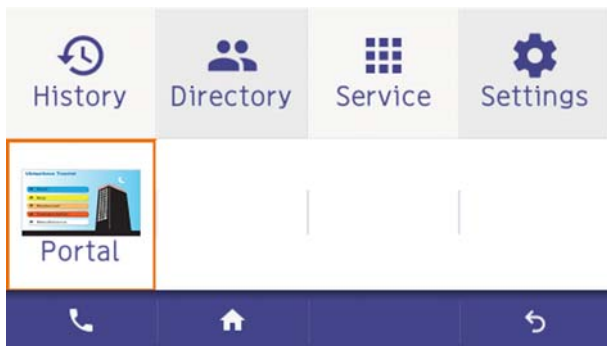





Normally, the name of the Portal screen icon is displayed as the name of the registered application.

## Menu Screen

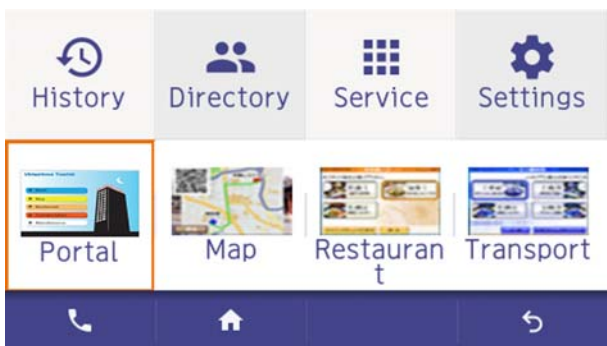

From the menu you can use various application features such as **Directory** and **History**.

Menu



	Menu/Icon	Description
Local Application	(1) History: 	To view <b>Call History</b> ; the history data stored in the server (system) memory (see <a href="#">Lowercase Character</a> ) and that stored in the memory of the telephone, such as the histories of missed calls, dialed numbers, and received calls (see <a href="#">9.CALL HISTORY OPERATION</a> ).
	(2) Directory: 	To use <b>Directory</b> features; there are three types of directory features. <ul style="list-style-type: none"> <li>• <b>Personal Directory</b>: Controlled by telephone set. For details, see <a href="#">8.DIRECTORY OPERATION</a>.</li> <li>• <b>Phonebook</b>: Controlled by the system. For details, see <a href="#">Phonebook</a>.</li> <li>• <b>Corporate Directory</b>: Controlled by the external XML server. For details, contact the System Administrator.</li> </ul>
	(3) Service: 	XML application screen registered in the service URL is displayed. When the service URL is not registered, <b>Service</b> icon is not displayed.
	(4) Setting: 	To make the user settings of DT930 such as incoming call and display, and download various files such as ringtones, Music on Hold, and directories. For details, see <a href="#">3.TERMINAL SETUP – CLASSIC</a> .

	Menu/Icon	Description
XML Services	(5) <b>Phone/Portal CG:</b> 	When the home URL is not registered, <b>Phone</b> screen icon is displayed.  When the home URL is registered, a screen icon of XML application which was registered as the home URL and the application name ( <b>Portal</b> ) are displayed.
	(6) <b>XML application 1</b>	You can launch up to four XML applications including the Portal screen at a time. The icons of the running applications are displayed on the Menu screen from the left. For details, see <a href="#">Multi-Window</a> .
	(7) <b>XML application 2</b>	
	(8) <b>XML application 3</b>	

	Menu/Icon	Description
Soft Keys	(9) <b>Phone icon:</b> 	When you select the <b>Phone</b> icon, a pop-up screen is displayed on an XML application screen. (For details, see <a href="#">Pop-up Windows</a> . When XML application is registered in the home URL, the phone icon is displayed. When a home URL is not registered, the phone icon is not displayed.  <i>Note: If pop-up window display is disabled at installation, this icon is not displayed.</i>
	(10) <b>Home URL icon:</b> 	XML application screen registered in the home URL is displayed. When the home URL is not registered, <b>Home URL</b> icon is not displayed.
	(11) <b>Back icon:</b> 	When you select the <b>Back</b> icon, you can go back to the previous screen.

#### TIP

By selecting an application icon using cursor key and press enter key, you can launch the application of Local Application/XML Service from the menu. Also you can launch the application of Local Application/XML Service directly by pressing digit key (1 ~ 8).

## Starting Up XML Application

DT930 has an XML browser function. You can display the information of XML application installed in an external server onto the LCD of DT930 and use various services in collaboration with the XML application. The following explains how to start the XML application from DT930. For more information, refer to manuals relating to XML applications.

### Starting from Menu Button

(1) Select **Service**.

Select an item by one of the following operations.

- Highlight an item by using cursor key, and press , or **OK**.
- Press **3**.

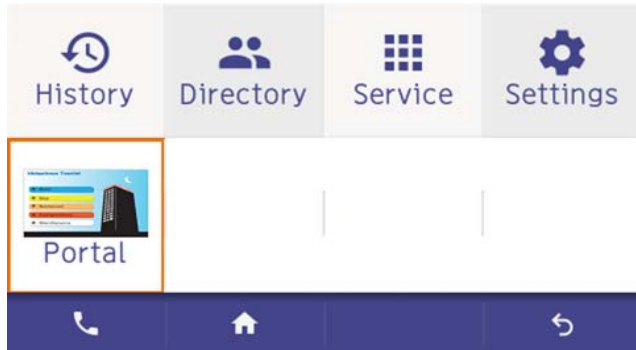

(2) XML Application will start up.

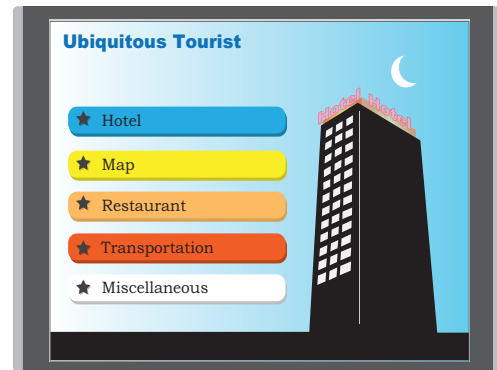

## Shortcut Menu

The LCD displays icons when there are missed calls or new voice mails. You can open shortcut menu by pressing  (**Enter**). You can also check missed calls or access the new voice mails from shortcut menu.

Top line of LCD (icon information area)

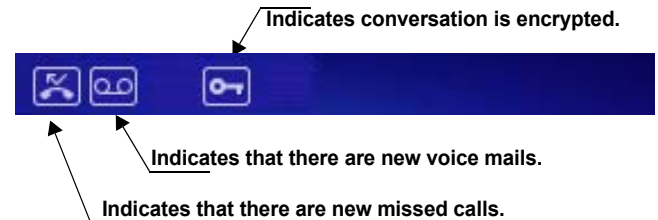

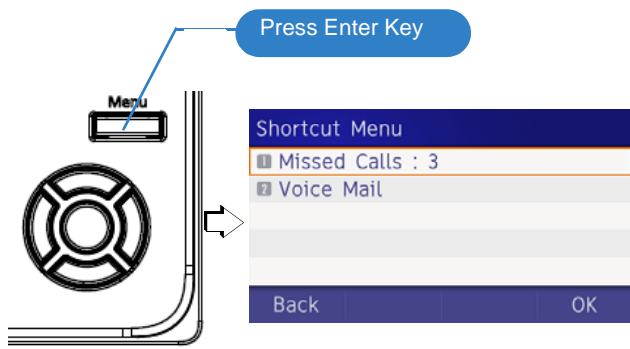

Unavailable Menu items are grayed out.

### Shortcut Menu

Feature	Description
1 Missed Calls	Access history of Missed Calls. The icon disappears after checking the history.
2 Voice Mail	Access history of incoming Voice Mail. The icon disappears after checking the voice mails. You must press the <b>Enter</b> key followed by <b>User Features</b> to display the Voice Mail tab.

### Status Icons

The LCD displays icons in the icon information area when there are missed calls or new voice mails. You can check the status at a glance, and access the services quickly.

The following icons are displayed:

Feature	Icon	Description
Missed Call		This icon appears when there is a missed call. Once you check the missed call, this icon will disappear.
Voice Mail		This icon provides notification of incoming Voice Mail. Once you check the mail, this icon will disappear.
Encryption		This icon appears when the conversation is encrypted.

### Soft Keys

**Soft Keys** on DT930 provide a set of functions on the LCD that adapts to the changing state of the telephone.



Patterns and names of Soft Keys to be displayed are set at installation. For details, contact the System Administrator.

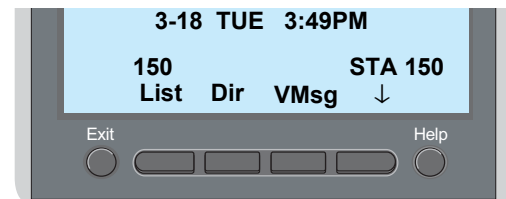

○ **Display Samples**

**Soft Keys** provide a set of functions on the LCD that adapts to the changing state of the telephone.

IDLE

3-18 TUE 3:49PM				
150				STA 150
List	Dir	VMsg		↓

DIAL TONE/DIALING

(1)

3-18 TUE 3:49PM				
VMsg	InPg	ExPg		↓

Push ↓ (Down Arrow)

(2)

3-18 TUE 3:49PM				
P/U	Barg	Save		↑

CALLING

3-18 TUE 3:49PM				
CALLING				STA 101
Voice	MW	VMsg		↓

BUSY

(1)

3-18 TUE 3:49PM				
BUSY				STA 101
MW	VMsg	Camp	Barg	

CONNECTION

3-18 TUE 3:49PM		
TALKING TO		101
Conf		

CONSULTATION HOLD

3-18 TUE 3:49PM			
HOLD			STA 101
VMsg	InPg	ExPg	↓

**How to Use Soft Keys**

This section provides some sample operations of features using **Soft Keys**.

**Example 1: DO NOT DISTURB**

(1) Press ↓ (Down Arrow).

3-18 TUE 3:49PM				
150				STA 150
List	Dir	VMsg		↓

(2) Press **Prog**.

3-18 TUE 3:49PM				
150				STA 150
ICM	Prog			↑

- (1) Press **DND**.

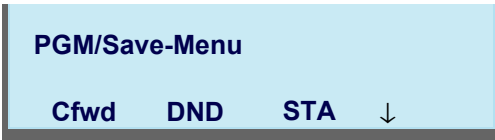

- (2) Press **Set** to set DND or **Cncl** to cancel it.

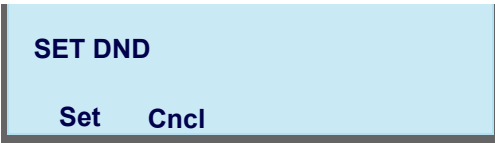

## Example 2: CALL FORWARD

- (1) Press ↓ (Down Arrow).

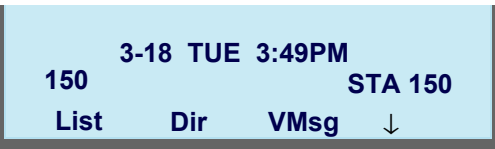

- (2) Press **Prog**.

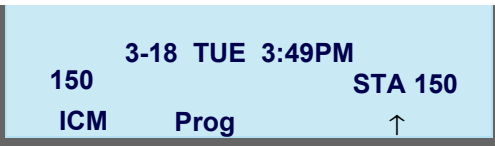

- (3) Press **Cfwd**.

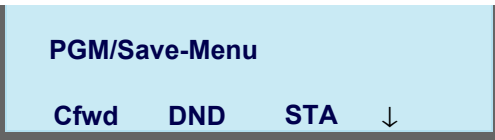

- (4) Select the Call Forward type.



- (5) Press **Set** to set Call Forward or **Cncl** to cancel.

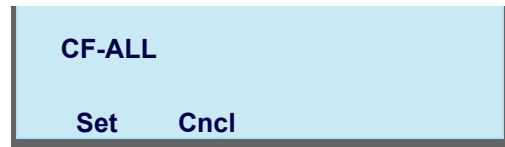

## Multi-Window

DT930 can display multiple windows at a time. As it is possible to launch multiple applications simultaneously, you can switch the displays quickly. If you receive an incoming call while displaying an application screen, you can operate line keys without exiting other applications first. You can go back to the previous application screen after operating the line keys.

## Switching XML Applications

The windows of the XML applications that are currently running are displayed as icons on the menu screen.

You can use this screen to switch windows to display. Select a service icon of the application that are currently running from the menu screen to display the XML application window.





- If the XM: application is not set, the most recently used XML application (i.e., Favorite, Phonebook, Terminal Settings) that the phone has by default is displayed.
- When the phonebook is displayed, the title of the phonebook is also displayed.

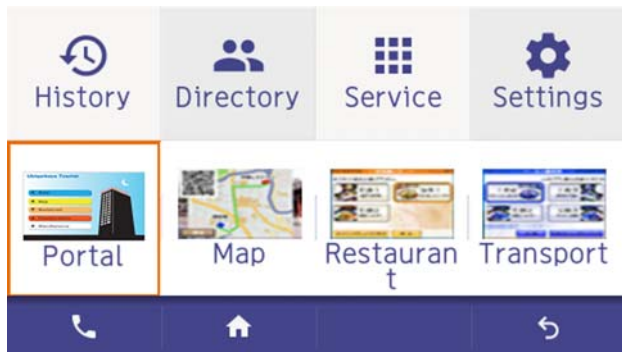

Select a service icon for the XML application you want to display.

### TIP

You can exit an XML application by pressing **Exit** while the LCD displays the XML application window. When you exit an XML application, the icons of other applications that are currently running are rearranged from left.

- Normally, only the Portal icon is displayed on the Desktop screen right after the phone is set up.

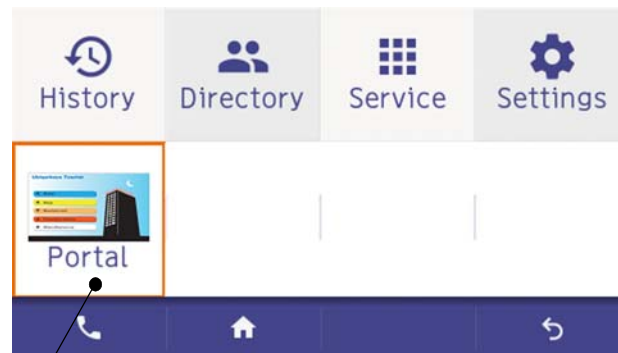

Home URL is registered.

- When you launch an XML application, the icon of the application appears to the right of the **Portal** icon on the **Desktop** screen.

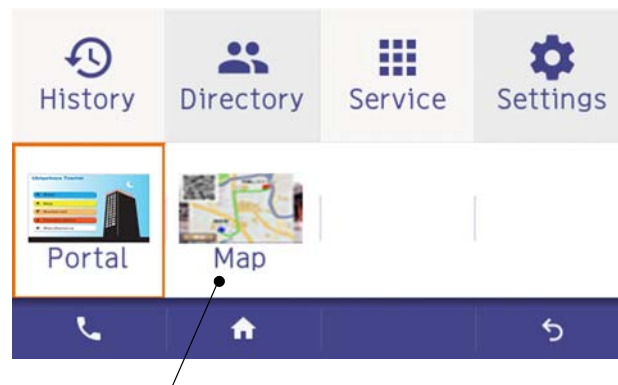

Displays icon for newly running XML application.

- You can launch up to four XML applications including the **Portal** window. The service icons of the running applications are displayed from the left in order of their launch.

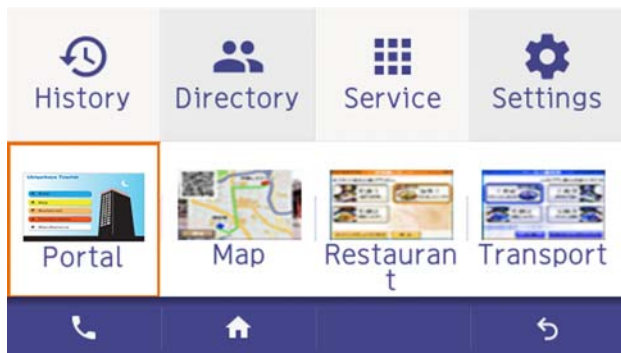

Displays up to four XML application icons.

**TIP**

If you launch the same XML application more than once, only one icon of the application is displayed on the menu screen.

## Switching Local Applications

Local applications such as **History**, **Directory**, and **Setting** are displayed in one window.

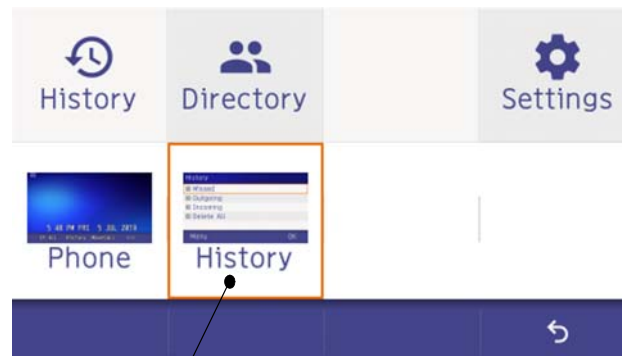

Local Application Icon

- Normally, only the **Portal** icon is displayed on the **Desktop** screen right after the phone is set up.

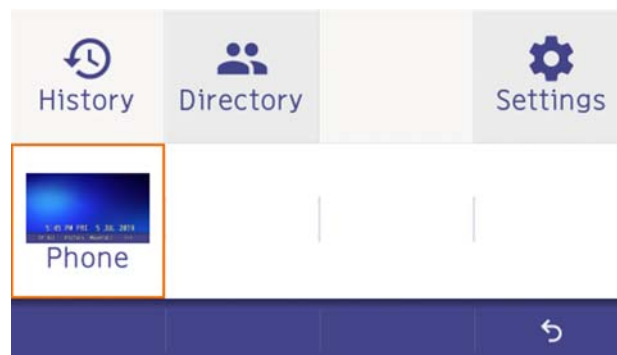

Home URL is not registered.

- Select a desired local application from icons to launch the application or setting **Menu**.

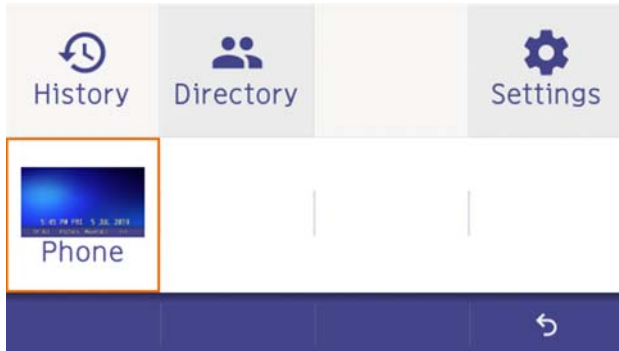

### TIP

If you select a local application by using a One-Touch key while launching other local application, new local application is not running. The initial screen of the currently running application is displayed.

## Launching the Fifth Application

You can launch up to four XML applications including **Portal** at a time. If you try to launch a fifth application, an error message to ask you to exit one of the currently running applications is displayed. While this error message is displayed, you cannot execute any operations on XML applications.

- If you try to launch a fifth application, an error message to ask you to exit one of the currently running applications is displayed.

Press **Next**.

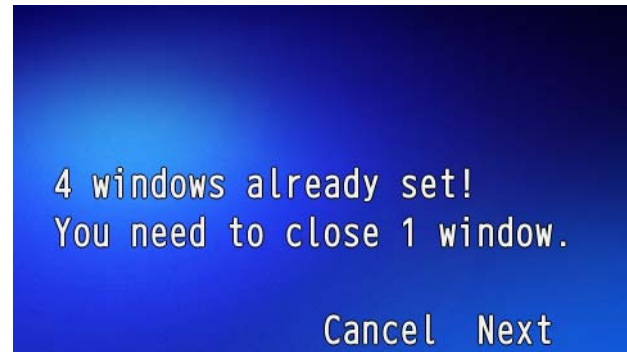

### TIP

If you do not operate anything for 10 seconds after an error message is displayed, the trial of launching the new application is automatically canceled.

- Application exit screen is displayed. Currently running XML application icons excluding the **Portal** are displayed. Select an application to exit. Now you can launch a new application.

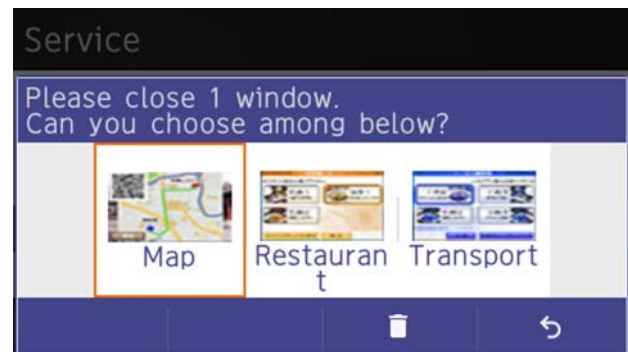

Currently running XML application icons, excluding the **Portal**.

- The icon for the application you quit disappears from the menu screen. The newly running application icon is added to the right.

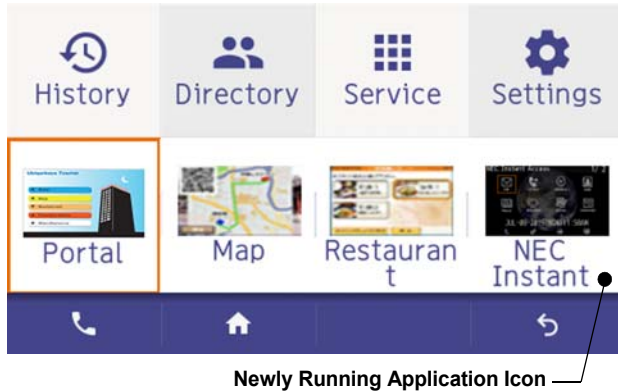

### Icon Display at XML Application Update

The service icons displayed on the menu screen are reduced screen images of actual XML application screens. The icon and the actual application display may differ because the system cannot iconize the screen image until it actually displays the application windows.

**NEW** icon is displayed when the application orders to display an icon that was formerly not displayed.

**UPDATE** icon is displayed when the window of the XML application is updated.

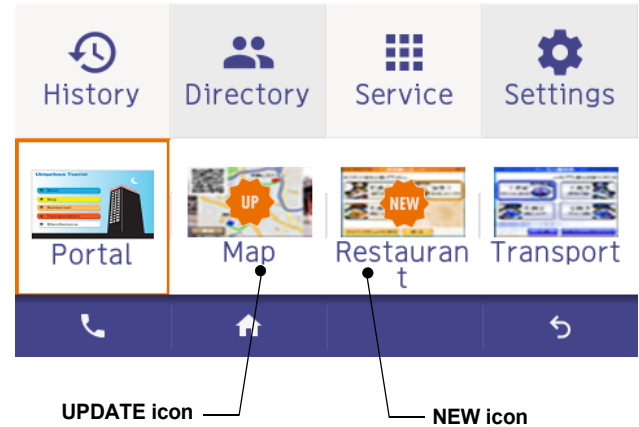

**TIP** | **NEW** and **UPDATE** icons flash every second.

**TIP** | **NEW/UPDATE** icon and **Application** icon appear alternately every second.

### Pop-up Windows

If there is an incoming call while the phone is displaying an XML application, or a local application such as **History** or **Directory**, a telephone service window appears as a pop-up window.

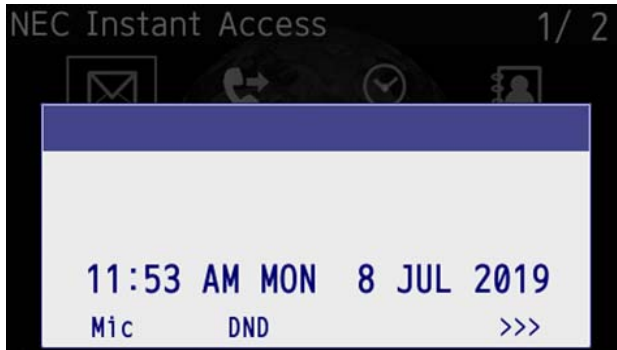

## Launching a Pop-Up Window

There are several ways to display a pop-up window as listed below.

### TIP

A procedure how to display a pop-up window is set at installation. For details, contact the System Administrator.

How to Display
By selecting Phone icon on the menu screen.
When there is an incoming call to the phone.
By going off-hook. (lifting the handset, etc.)
When receiving a request from the XML application server.
By pressing POP-UP on an XML application.
When the system directs resource release.
By pressing Help key on the menu screen

### TIP

If the previous page of the menu screen is the default home screen, the telephone icon of the menu screen will not be displayed.

### TIP

When using Help key on the POP-UP window, Help key operation setting is required. For details, see [Set Usability](#).

## Exiting a Pop-Up Window

A pop-up window closes when:

- is pressed to display the menu screen.
- The phone goes on-hook.
- The call is abandoned before being answered.
- XML application server directs to do so.
- Pop-Up Close** on the XML application is pressed.



This page is for your notes.

# 3. TERMINAL SETUP – CLASSIC

This chapter describes operating procedures for terminal settings. Various terminal settings such as display, sounds, password and language are available.



## Setup With Up/Down Key

### Adjust Handset Receiver Volume

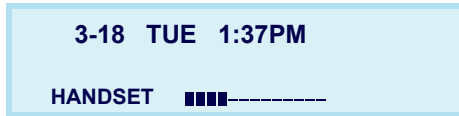
- (1) Press  (Up) or  (Down) in the off-hook status or during a call.



### Adjust Speaker Volume

- (1) Press  (Up) or  (Down) during speakerphone operation or during a call.

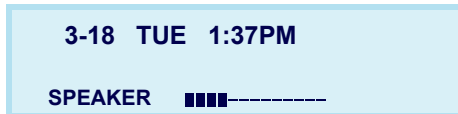

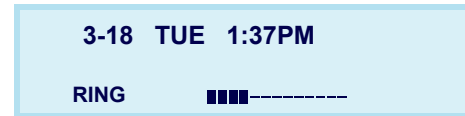

### Adjust Ringer Tone

- (1) Press  (Up) or  (Down) during ringing.



## Setup With Feature Key

### Microphone On/Off

- (1) LED on  shows the status of the built-in microphone.
- (2) Press the MIC key or press  and **1**.



## Setup with Menu Key

### Enable/Disable Off-Hook Ringing

The procedure below shows how to enable/disable Off-hook ringing.

- (1) Display the **Menu** screen, select **Setting**.
- (2) Select **1 User Setting**.

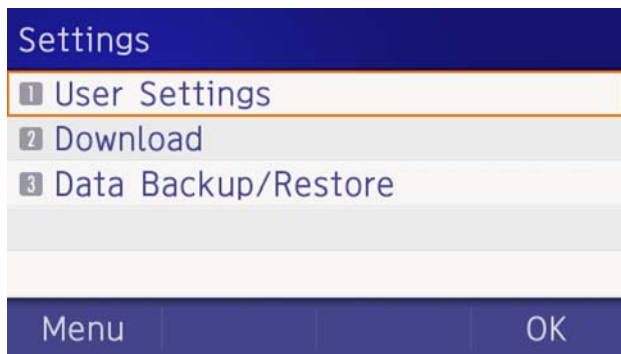

Select an item by one of the following operations.

- Highlight an item by using , and press ,  or **OK**.
- Press **1**.



- (3) Select **1 Incoming Call**.

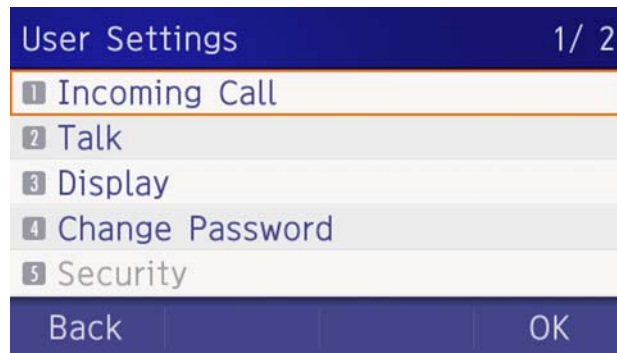

Select an item by one of the following operations.

- Highlight an item by using , and press ,  or **OK**.
- Press **1**.



- (4) Select **1 Offhook Ring**.

Select an item by one of the following operations.

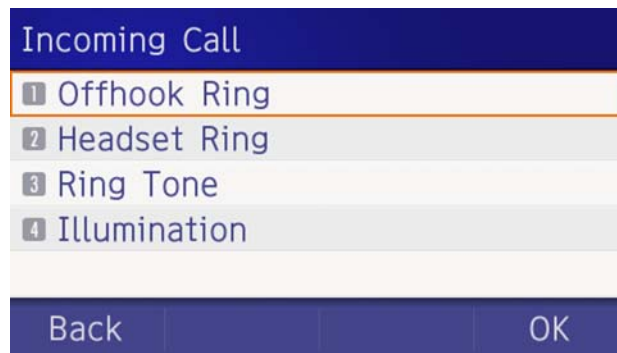

- Highlight an item by using , and press ,  or **OK**.
- Press **1**.





- (5) To disable/enable the off-hook ringing, choose **1 Disable** or **2 Enable**.

Select an item by one of the following operations.

- Highlight an item by using , and press  or **OK**.
- Press **1** or **2**, and press  or **OK**.





**TIP** Default setting is **Enabled**.

**TIP** The enabled item is highlighted.

### Set Ringing of Headset

The procedure below shows how to enable/disable the ringing of headset.

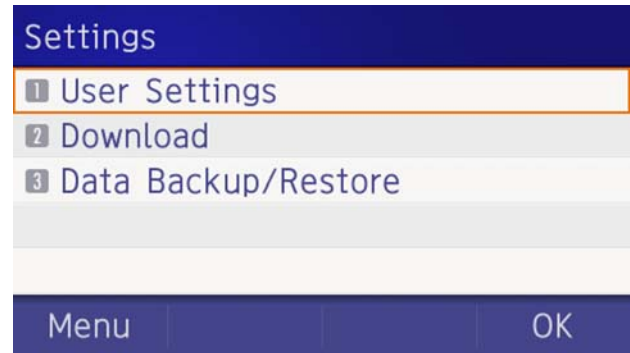

- (1) Display the **Menu** screen, select **Setting**.
- (2) Select **1 User Setting**.  
Select an item by one of the following operations.

- Highlight an item by using , and press , or **OK**.
- Press **1**.



- (3) Select **1 Incoming Call**.

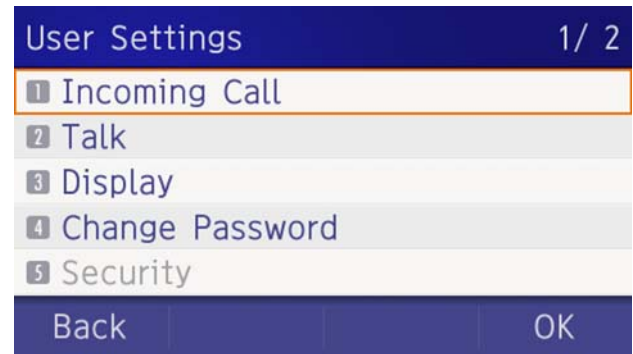

Select an item by one of the following operations.

- Highlight an item by using , and press ,  or **OK**.
- Press **1**.



(4) Select **2 Headset Ring**.

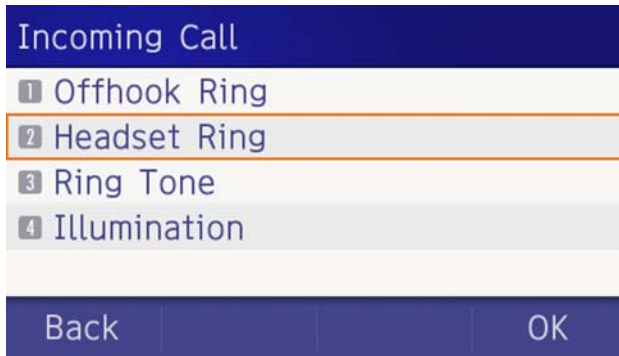

Select an item by one of the following operations.

- Highlight an item by using , and press , or **OK**.
- Press **2**.



(5) To disable/enable the ringing of headset, choose **1 Disable** or **2 Enable**.

Select an item by one of the following operations.

- Highlight an item by using , and press , or **OK**.

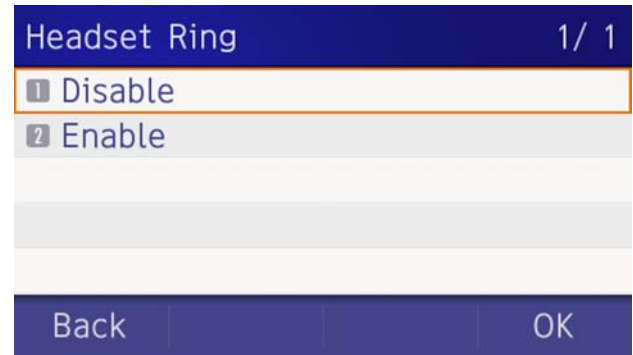

- Press **1** or **2**, and press  or **OK**.



**TIP** | Default setting is **Disabled**.

### Set Ringer Tone

The procedure below shows how to change the ringer tone for internal call and external call.

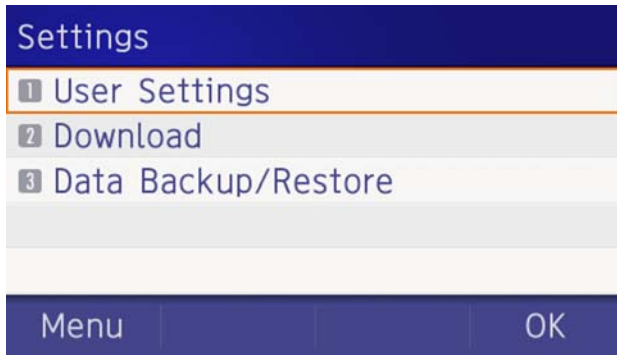

- (1) Display the **Menu** screen, select **Setting**.
- (2) Select **1 User Setting**.  
Select an item by one of the following operations.
  - Highlight an item by using , and press , or **OK**.

- Press **1**.



- (3) Select **1 Incoming Call**.

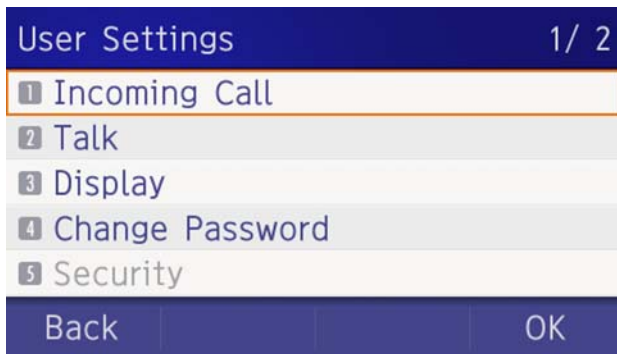

Select an item by one of the following operations.

- Highlight an item by using , and press , or **OK**.
- Press **1**.



- (4) Select **3 Ring Tone**.

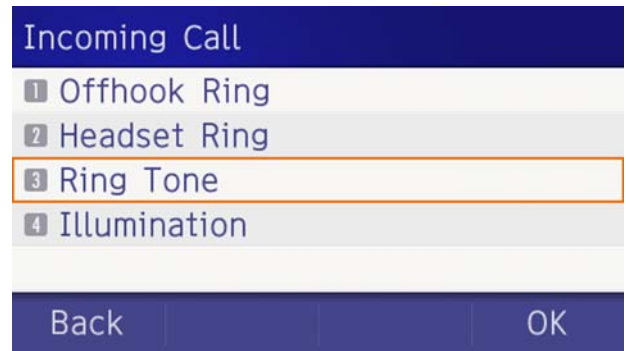

Select an item by one of the following operations.

- Highlight an item by using , and press , or **OK**.
- Press **3**.



- (5) Select **1 External Call** when setting the ringer tone for external calls. Select **2 Internal Call** when setting the ringer tone for internal calls.

Select an item by one of the following operations.

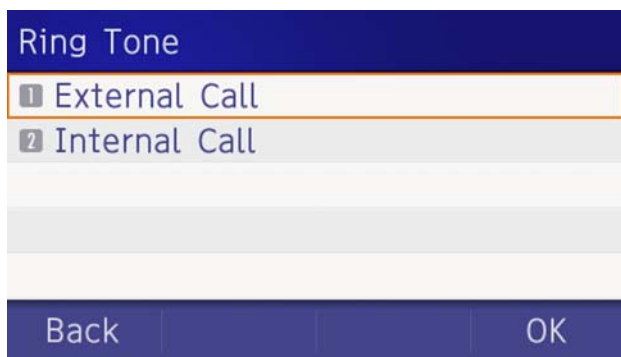

- Highlight an item by using , and press , or **OK**.

- Press **1** or **2**.



- (6) Select a desired tone type. You can preview designated ringer tone.

Select an item by one of the following operations.

- Highlight an item by using , and press  or **OK**.
- Press the digit key of desired number, and press  or **OK**.  
For example, press **1** + **5** to select **15**  
**Download 1**.

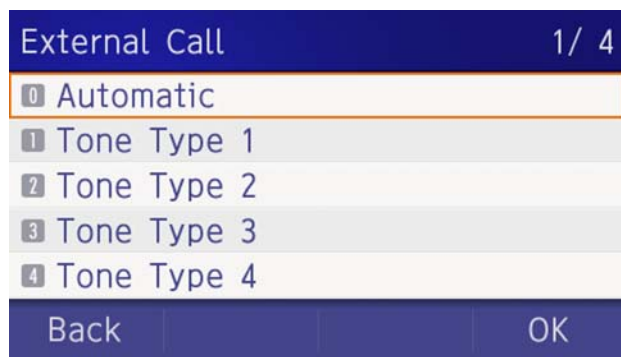

No.	Menu Item	Frequency (Hz)		Remarks
		1st	2nd	
0	Automatic	520	660	16Hz modulation
1	Tone Type 1	520	660	16Hz modulation
2	Tone Type 2	520	660	8Hz modulation
3	Tone Type 3	1400	1100	Door Phone
4	Tone Type 4	1100		No modulation
5	Tone Type 5	540		No modulation
6	Tone Type 6	1100	1400	16Hz modulation
7	Tone Type 7	660	760	16Hz modulation
8	Tone Type 8	1100		Envelope
9	Tone Type 9	-		Door Phone Melody
10	Tone Type 10	-		Melody 1
11	Tone Type 11	-		Melody 2
12	Tone Type 12	-		Melody 3
13	Tone Type 13	-		Melody 4
14	Tone Type 14	-		Melody 5
15	Download 1	-		C Major Ring Tone (See note below.)
16	Download 2	-		Canon (See note below.)
17	Download 3	-		Turkish March (See note below.)

*Note:* There are three pre-installed melodies on the DT900 telephones. They include: Download 1: C major ringtone, Download 2: Canon and Download 3: Turkish March.

*These pre-installed melodies are overwritten when you download a new ringtone.*

*Note:* When selecting **Automatic** or not performing this ringer tone setting, **Tone Type 1** is automatically applied.

**Note:** When selecting **Automatic**, the preview function will not operate. Also, when selecting **Download 1/2/3**, the ringer tone file must be downloaded in advance. If there is no downloaded file, you hear no tone.

**Note: Tone Type 1 to Tone Type 8:**

In the preview function, each ringer tone sounds continuously. Actual ringer pattern of each tone is determined by the initial system settings.

**Note:** Terminal settings may not become effective, according to the system settings. For details, contact the System Administrator.

**TIP** The enabled item is highlighted.



**TIP** You can set the ringer tone for the telephone here. Ringer Tone type can be set for **Name**, **Group** and **Telephone set**. The ringer Tone type set for **Name** has higher priority than the types set for **Group** and **Terminal set**.

## Set Illumination Pattern for Call Indication Lamp

The procedure below shows how to set the illumination pattern (color of Call Indicator Lamp).

- (1) Display the **Menu** screen, select **Setting**.
- (2) Select **1 User Setting**.

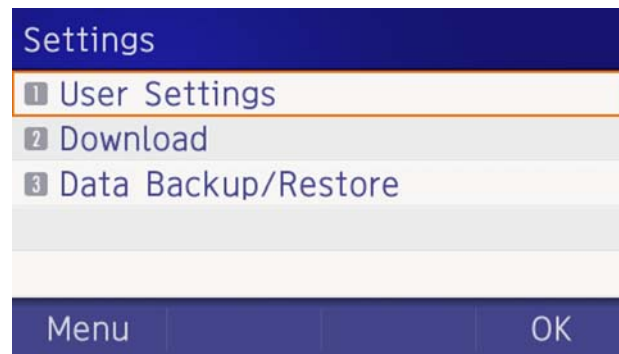

Select an item by one of the following operations.

- Highlight an item by using , and press , or **OK**.
- Press **1**.



- (3) Select **1 Incoming Call**.

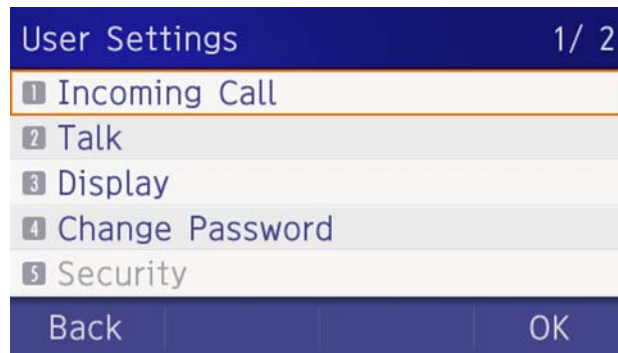

Select an item by one of the following operations.

- Highlight an item by using , and press , or **OK**.
- Press **1**.



(4) Select **4 Illumination**.

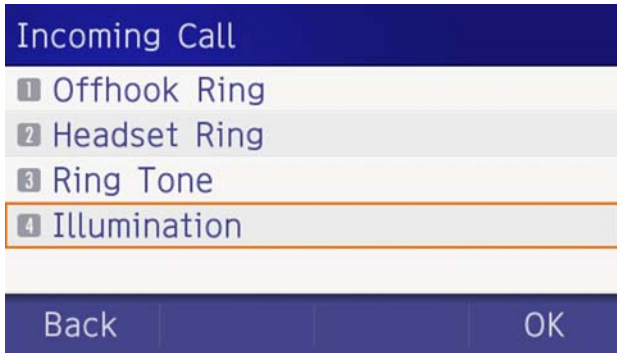

Select an item by one of the following operations.

- Highlight an item by using , and press ,  or **OK**.
- Press **4**.



(5) Select **1 External Call** when setting the illumination pattern for external calls. Select **2 Internal Call** when setting the illumination pattern for internal call.

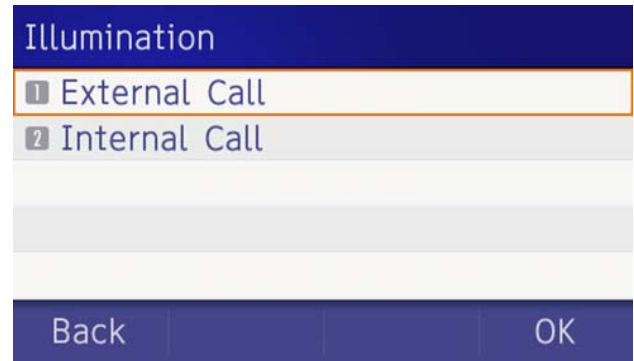

Select an item by one of the following operations.

- Highlight an item by using , and press ,  or **OK**.
- Press **1** or **2**.



(6) Select a desired illumination pattern. You can preview the designated illumination pattern.

Select an item by one of the following operations.

- Highlight an item by using , and press  or **OK**.
- Press **0** - **9**, and press  or **OK**.

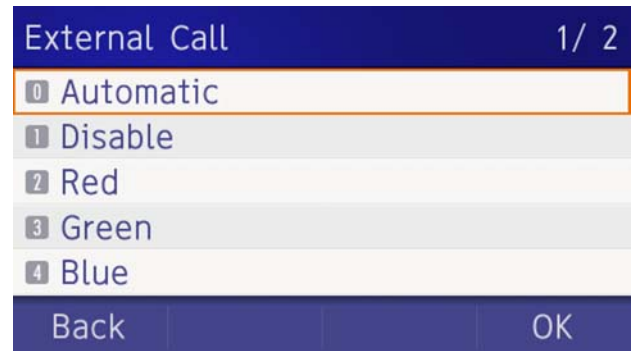

**Note:** When selecting **Automatic**, the preview function will not operate.

**Note:** When selecting **Automatic** or not performing this illumination setting, **Red** is automatically applied.

**TIP**



You can set the illumination pattern for the telephone here. Illumination pattern can be set for **Name**, **Group** and **Telephone set**. The illumination pattern set for **Name** has higher priority than the patterns set for **Group** and **Terminal set**.

### Enable/Disable RTP Alarm

The procedure below shows how to enable/disable RTP alarm.

- (1) Display the **Menu** screen, select **Setting**.
- (2) Select **1 User Setting**.

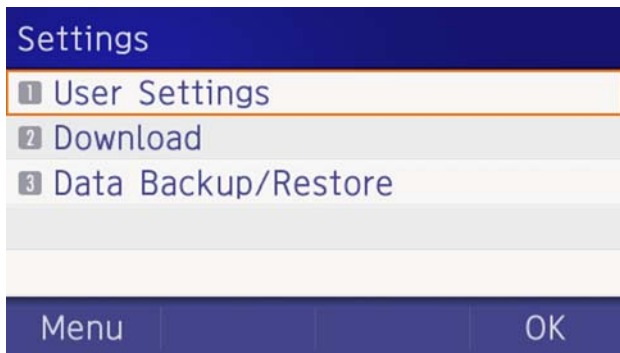

Select an item by one of the following operations.

- Highlight an item by using , and press , or **OK**.
- Press **1**.



- (3) Select **2 Talk**.

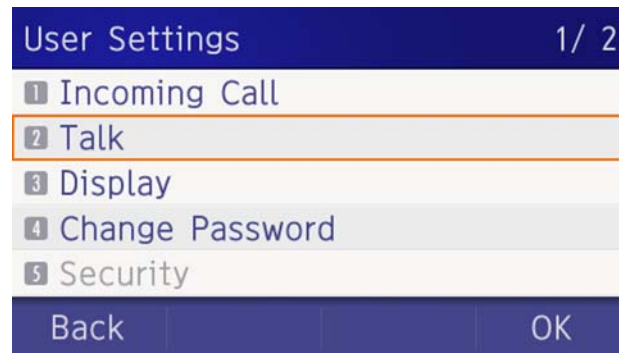

Select an item by one of the following operations.

- Highlight an item by using , and press , or **OK**.
- Press **2**.



- (4) Select **1 RTP Alarm**.

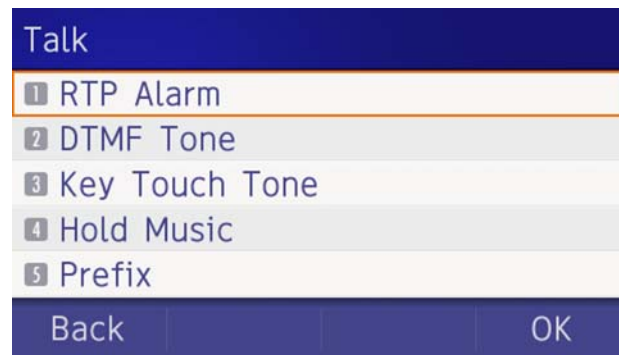

Select an item by one of the following operations.

- Highlight an item by using , and press , or **OK**.
- Press **1**.



- (5) Select **0 Automatic**, **1 Disable** or **2 Enable** (see the following table).

Select an item by one of the following operations.

- Highlight an item by using , and press  or **OK**.
- Press **0** - **2**, and press  or **OK**.

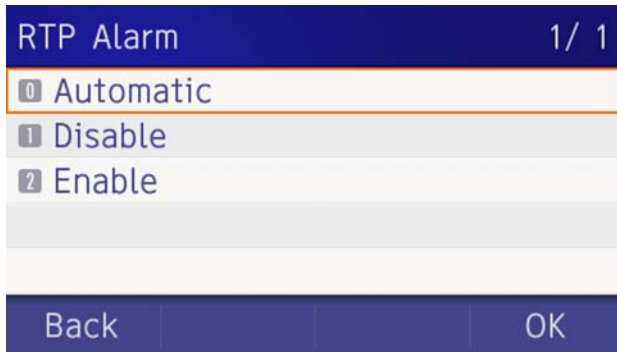

Menu Items	Description
0 Automatic	Follow the system settings. If no setting is made in the system, the default setting (Alarm=ON) is applied.
1 Disable	Follow the terminal settings (OFF).
2 Enable	Follow the terminal settings (ON).



- TIP** For the setting on the system, contact the System Administrator.
- TIP** Default setting is **Automatic**.
- TIP** The enabled item is highlighted.

## Enable/Disable DTMF Tone

The procedure below shows how to enable/disable DTMF Tone.

- (1) Display the **Menu** screen, select **Setting**.
- (2) Select **1 User Setting**.

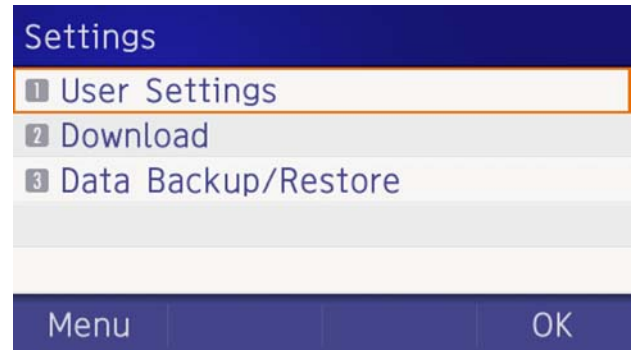

Select an item by one of the following operations.

- Highlight an item by using , and press ,  or **OK**.
- Press **1**.



- (3) Select **2 Talk**.

Select an item by one of the following operations.



- Highlight an item by using , and press ,  or **OK**.
- Press **2**.

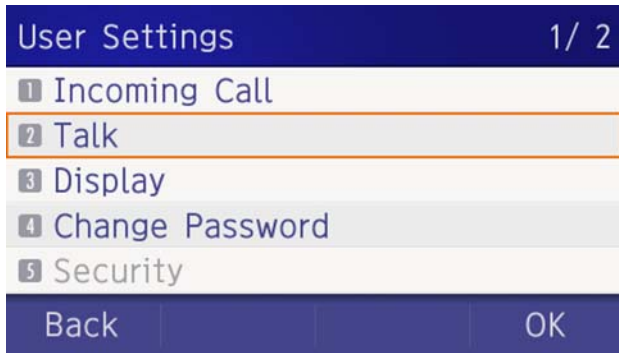



(4) Select **2 DTMF Tone**.

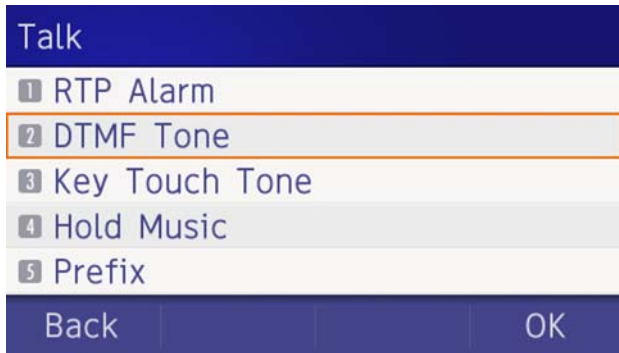

Select an item by one of the following operations.

- Highlight an item by using , and press , or **OK**.
- Press **2**.



(5) Select **0 Automatic**, **1 Disable** or **2 Enable** (see the following table).

Select an item by one of the following operations.

- Highlight an item by using , and press  or **OK**.
- Press **0** - **2**, and press  or **OK**.

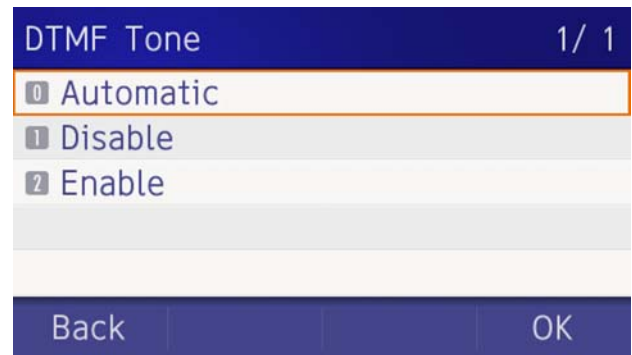

Menu Items	Description
0 Automatic	Follow the system settings. If no setting is made in the system, the default setting (DTMF=ON) is applied.
1 Disable	Follow the terminal settings (OFF).
2 Enable	Follow the terminal settings (ON).



- TIP** For the setting on the system, contact the System Administrator.
- TIP** Default setting is **Automatic**.
- TIP** The enabled item is highlighted.

## Set Key Touch Tone

The procedure below shows how to set the Key Touch Tone. Key Touch Tone is a tone generated when the digit keys are pressed while DT930 is off-hook.

- (1) Display the **Menu** screen, select **Setting**.
- (2) Select **1 User Setting**.

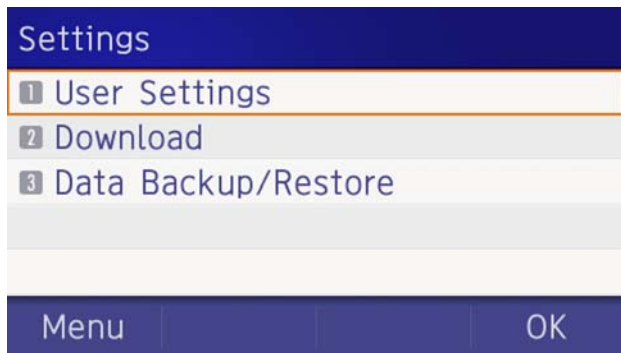

Select an item by one of the following operations.

- Highlight an item by using , and press , or **OK**.
- Press **1**.



- (3) Select **2 Talk**.

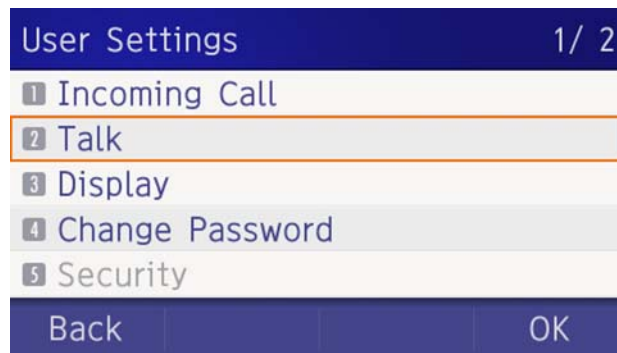

Select an item by one of the following operations.

- Highlight an item by using , and press , or **OK**.
- Press **2**.



- (4) Select **3 Key Touch Tone**.

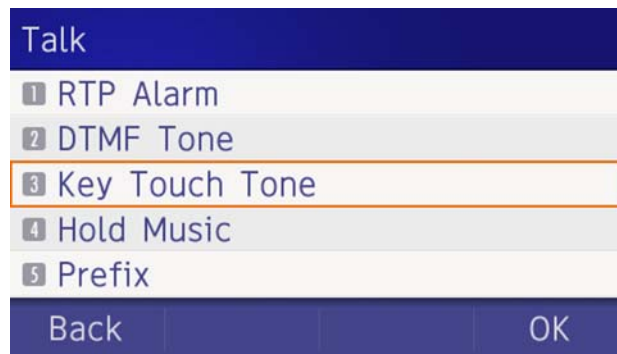

Select an item by one of the following operations.

- Highlight an item by using , and press , or **OK**.
- Press **3**.



- (5) Select **0 Automatic**, **1 No Tone**, **2 Tone** or **3 Voice**.

Select an item by one of the following operations.

- Highlight an item by using , and press  or **OK**.
- Press **0** - **3**, and press  or **OK**.

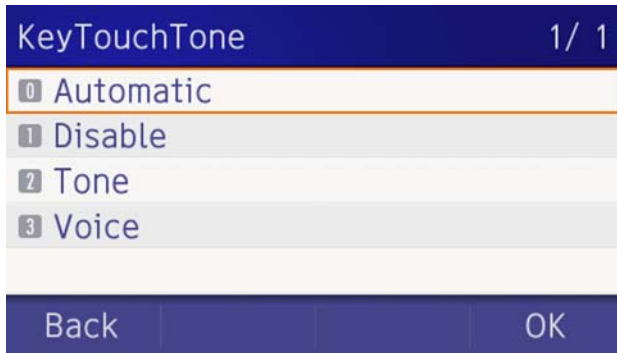

*Note:* When **Automatic** is set, the default setting (**Tone**) is applied.

**TIP** Default setting is **Automatic**.



**TIP** The enabled item is highlighted.

### Set Music on Hold

The procedure below shows how to set Music on Hold to be heard by DT930 user.

- (1) Display the **Menu** screen, select **Setting**.
- (2) Select **1 User Setting**.

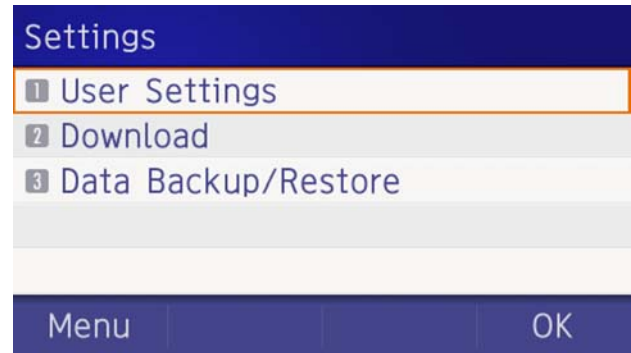

Select an item by one of the following operations.

- Highlight an item by using , and press , or **OK**.
- Press **1**.



- (3) Select **2 Talk**.

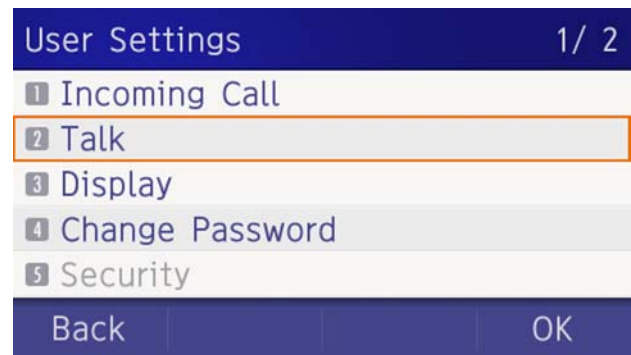

Select an item by one of the following operations.

- Highlight an item by using , and press , or **OK**.
- Press **2**.



(4) Select **4 Hold Music**.

Select an item by one of the following operations.

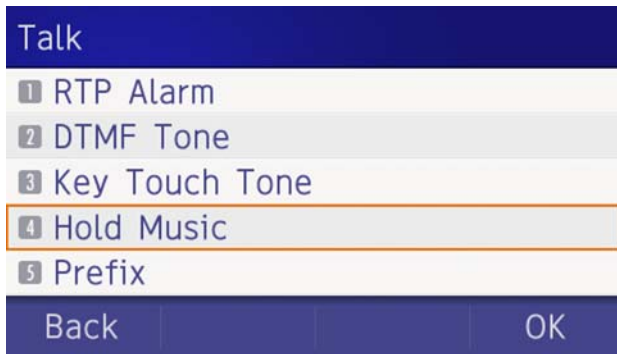

- Highlight an item by using , and press , or **OK**.
- Press **4**.



(5) Select a desired Music on Hold. You can preview the designated Music on Hold.

Choose **1 Default** when the default data (Minuet) is used as Music on Hold. Choose **2 Download** when a downloaded data is used as Music on Hold.

Select an item by one of the following operations.

- Highlight an item by using , and press , or **OK**.
- Press **1** or **2**, and press  or **OK**.

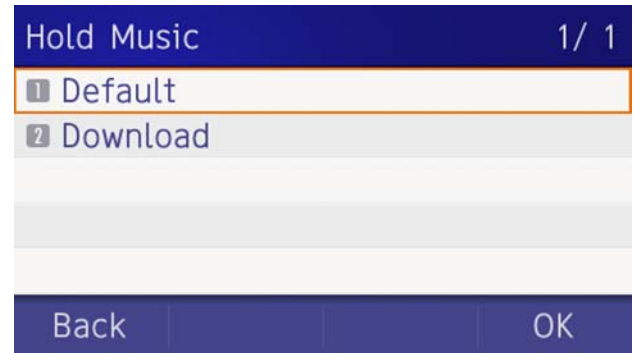

**Note:** You can preview the designated music on hold. When selecting **Download**, the music on hold file must be downloaded in advance. If there is no downloaded file, you hear no tone in the preview function (in actual operating conditions, “Minuet” is automatically applied.).

**TIP** Default setting is **Default** (Minuet).

**TIP** The enabled item is highlighted.



## Set Clock Format

Determines whether the time is displayed using a 12-hour or 24-hour clock format.

**Note:** This setting is available for *Time Display* only. Call *Log* feature displays the time in 24-hour format regardless of this setting.

- (1) Display the **Menu** screen, select **Setting**.
- (2) Select **1 User Setting**.

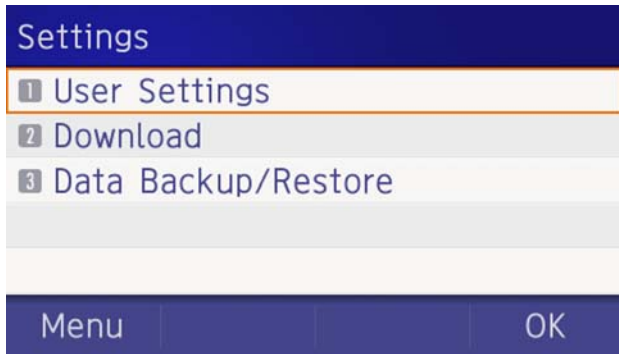

Select an item by one of the following operations.

- Highlight an item by using , and press , or **OK**.
- Press **1**.



(3) Select **3 Display**.

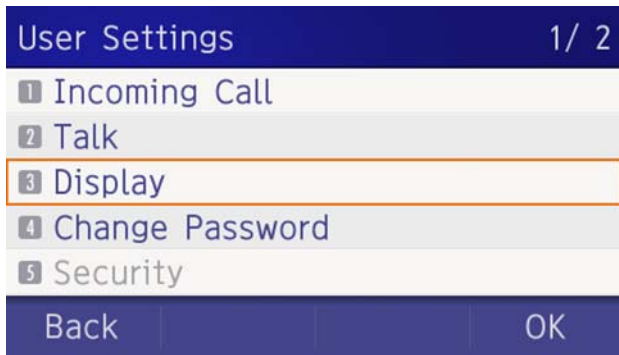

Select an item by one of the following operations.

- Highlight an item by using , and press , or **OK**.
- Press **3**.



(4) Select **1 Calendar Format**.

Select an item by one of the following operations.

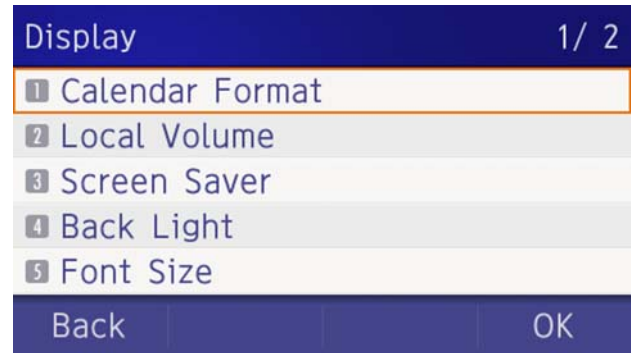

- Highlight an item by using , and press , or **OK**.
- Press **1**.

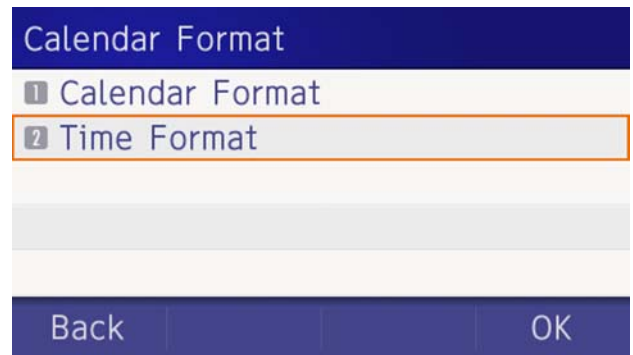

(5) Select **2 Time Format**.





Select an item by one of the following operations.

- Highlight an item by using , and press , or **OK**.
- Press **2**.

(6) Make a selection from the following list.

Select an item by one of the following operations.

- Highlight an item by using , and press  or **OK**.
- Press **0** - **2**, and press  or **OK**.

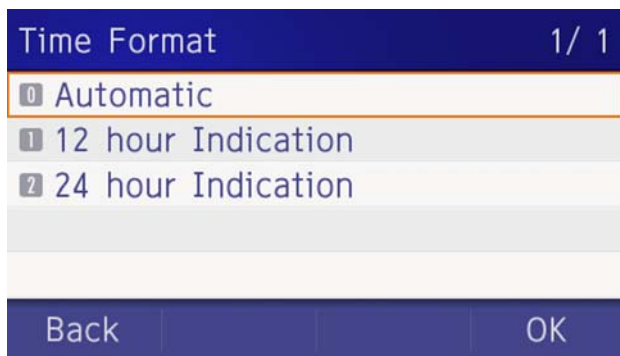

Menu Items	Description
0 Automatic	Follow the system settings.
1 12-hour indication	12-hour clock
2 24-hour indication	24-hour clock

**Note:** When selecting **Automatic** or not performing this time format setting, **12-hour clock** is automatically applied.

**TIP** For the setting on the system, contact the System Administrator.

**TIP** Default setting is **Automatic**.

**TIP** The enabled item is highlighted.



## Enable/Disable Volume Level Display

Determines whether or not to display the following volume levels: handset receiver volume, speaker volume, ringer tone volume and LCD contrast.

(1) Display the **Menu** screen, select **Setting**.

(2) Select **1 User Setting**.

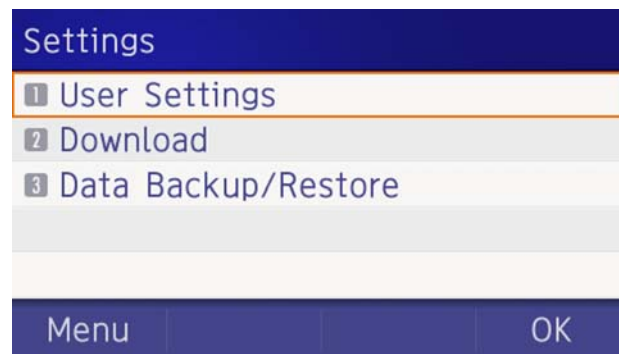

Select an item by one of the following operations.

- Highlight an item by using , and press , or **OK**.
- Press **1**.



(3) Select **3 Display**.

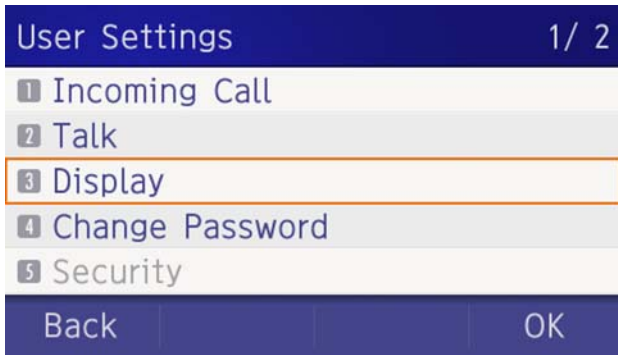

Select an item by one of the following operations.

- Highlight an item by using , and press , or **OK**.
- Press **3**.



(4) Select **2 Local Volume**.

Select an item by one of the following operations.

- Highlight an item by using , and press , or **OK**.
- Press **2**.

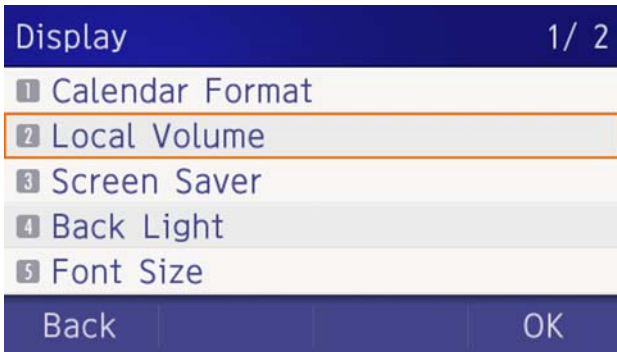

(5) Make a selection from the following list.

Select an item by one of the following operations.

- Highlight an item by using , and press  or **OK**.
- Press **0** - **2**, and press  or **OK**.

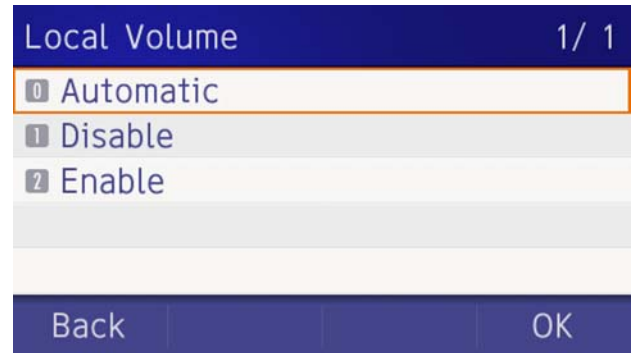

Menu Items	Description
0 Automatic	Each volume level is displayed on LCD.
1 Disable	Each volume level is not displayed on LCD.
2 Enable	Each volume level is displayed on LCD.

**Note:** When 0 **Automatic** is set, the default setting (**Enable**) is applied.

- TIP** Default setting is **Automatic**.
- TIP** The enabled item is highlighted.



## Set Screen Saver

Screen Saver works after the telephone is idle for a certain period of time. The Screen Saver will be displayed from XML server when the XML server is available. If the Screen Saver cannot be downloaded from the XML server, the default Screen Saver will be displayed.

*Note:* For details on the XML service, contact the System Administrator.

- (1) Display the **Menu** screen, select **Setting**.
- (2) Select **1 User Setting**.

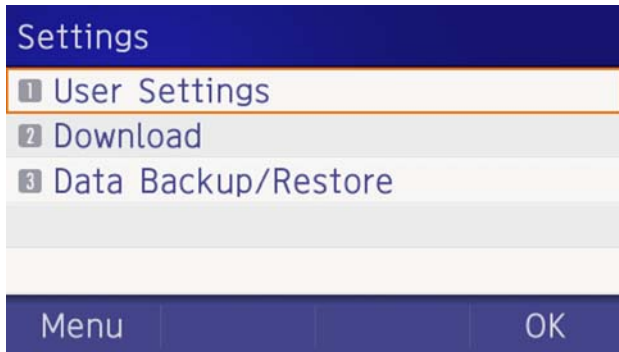

Select an item by one of the following operations.

- Highlight an item by using , and press , or **OK**.
- Press **1**.



- (3) Select **3 Display**.

Select an item by one of the following operations.

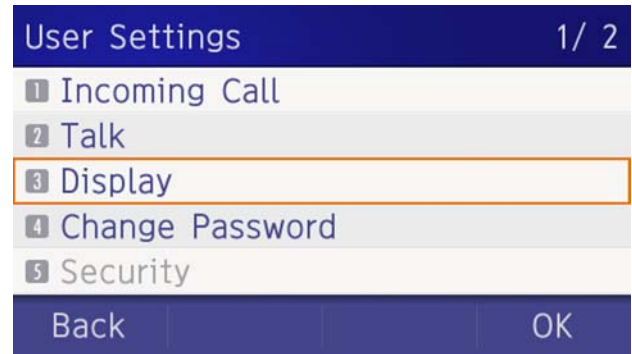

- Highlight an item by using , and press , or **OK**.

- Press **3**.



- (4) Select **3 Screen Saver**.

Select an item by one of the following operations.

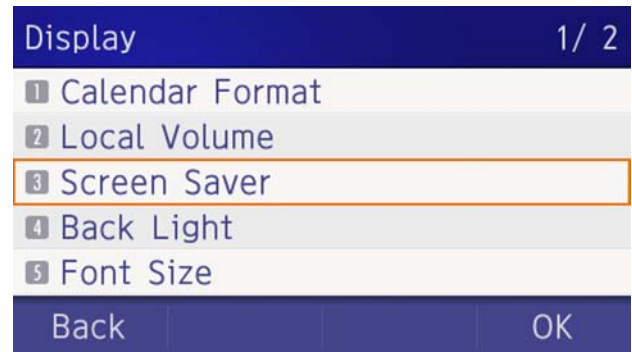

- Highlight an item by using , and press , or **OK**.
- Press **3**.





(5) Choose **1** **Screen Saver Mode**.



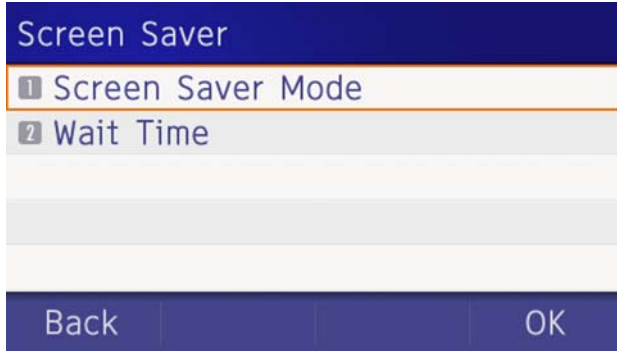

Select an item by one of the following operations.

- Highlight an item by using , and press ,  or **OK**.
- Press **1**.



(6) Choose either **1** **Disable** or **2** **Enable**.

Select an item by one of the following operations.

- Highlight an item by using , and press ,  or **OK**.
- Press **1** or **2**, and press  or **OK**.

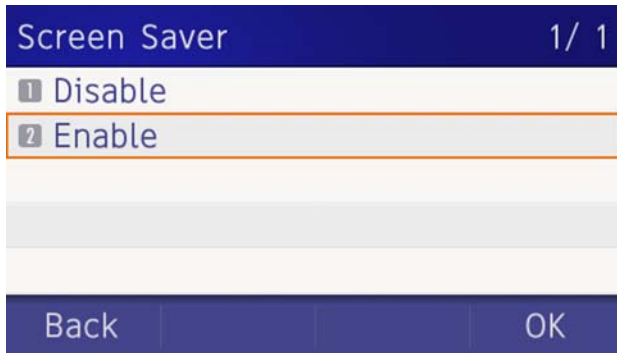

**TIP** Default setting is **Enable**.

**TIP** The enabled item is highlighted.

(7) The display returns to the Screen Saver screen. When **2** **Enable** is selected, on Step 7 Select **2** **Wait Time**.

Input **Wait Time** to launch the screen saver (1-999 min) and press  or **OK**.

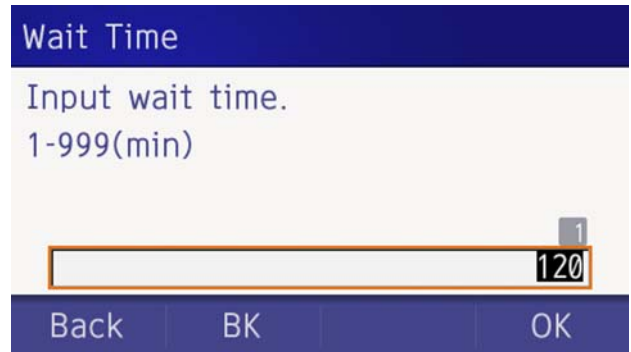

**TIP** Default value is **30 min**.



### Set Brightness of Backlight

The following steps show how to set the brightness level of the LCD backlight.

(1) Display the **Menu** screen, select **Setting**.

(2) Select **1** **User Setting**.

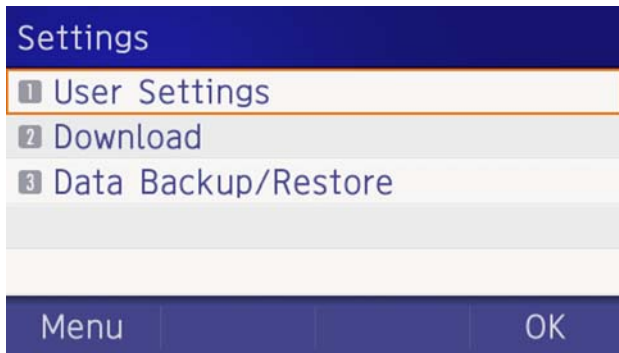

Select an item by one of the following operations.

- Highlight an item by using , and press ,  or **OK**.
- Press **1**.



(3) Select **3 Display**.

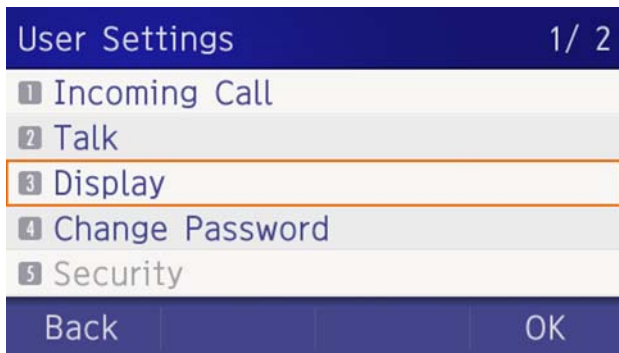

Select an item by one of the following operations.

- Highlight an item by using , and press , or **OK**.
- Press **3**.



(4) Select **4 Back Light**.

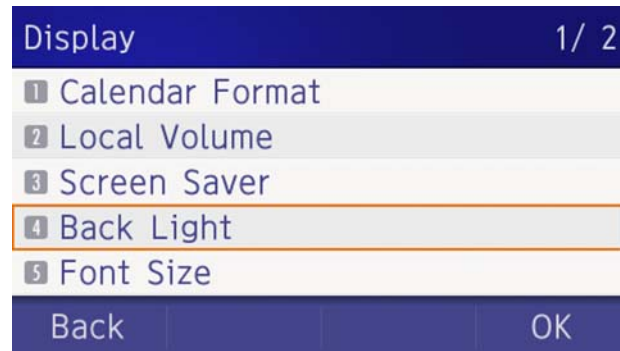

Select an item by one of the following operations.

- Highlight an item by using , and press , or **OK**.
- Press **4**.



(5) Select a desired brightness level.

Select an item by one of the following operations.

- Highlight an item by using , and press  or **OK**.
- Press **1** - **4**, and press  or **OK**.

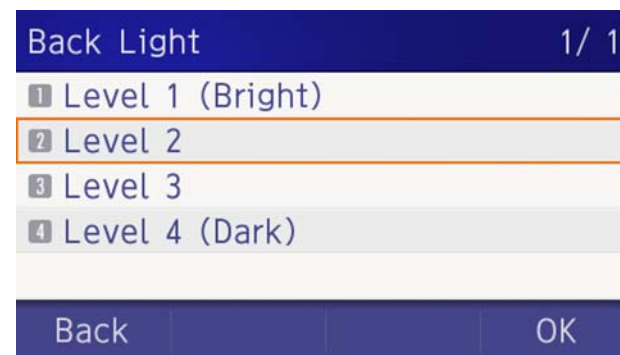

**TIP** Default setting is **Level 3**.

**TIP** The enabled item is highlighted.



## Change Character Size

The following steps show how to change the displayed character size on the LCD.

(1) Display the **Menu** screen, select **Setting**.

(2) Select **1** **User Setting**.

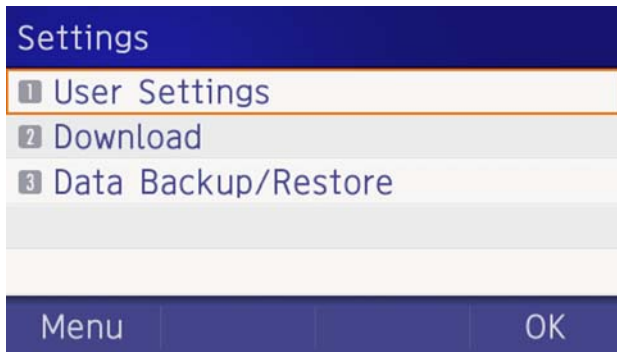

Select an item by one of the following operations.

- Highlight an item by using , and press , or **OK**.
- Press **1**.



(3) Select **3** **Display**.

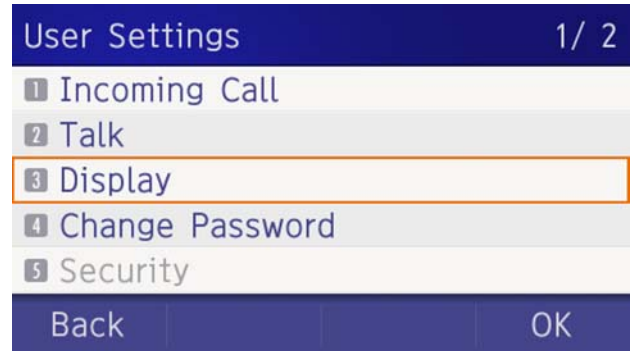

Select an item by one of the following operations.

- Highlight an item by using , and press , or **OK**.
- Press **3**.



(4) Select **5** **Font Size**.

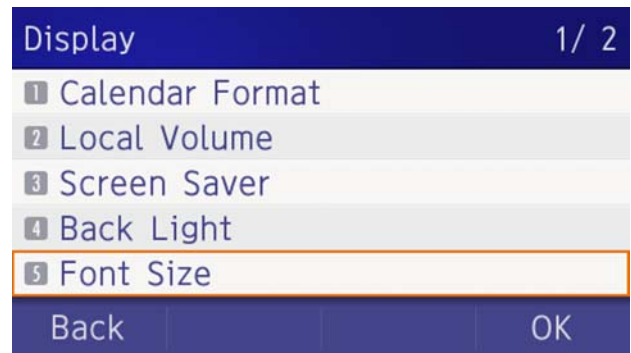

Select an item by one of the following operations.

- Highlight an item by using , and press , or **OK**.
- Press **5**.



(5) Choose either **Standard** or **Small**.

Select an item by one of the following operations.

- Highlight an item by using , and press  or **OK**.
- Press **1** or **2**, and press  or **OK**.



**TIP** Default setting is **Standard**.



**TIP** The enabled item is highlighted.

### Set a Language

The following explains how to set a language to be displayed on LCD.

- (1) Display the **Menu** screen, select **Setting**.
- (2) Select **1 User Setting**.

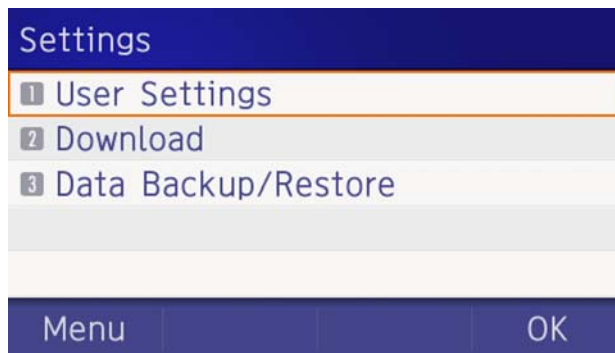

Select an item by one of the following operations.

- Highlight an item by using , and press , or **OK**.
- Press **1**.



(3) Select **3 Display**.

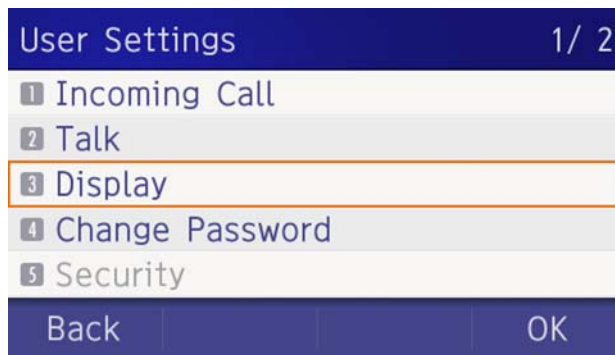

Select an item by one of the following operations.

- Highlight an item by using , and press , or **OK**.
- Press **3**.



(4) Select **6** Language.

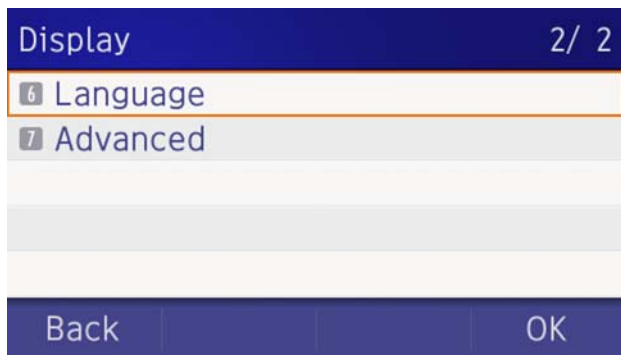

Select an item by one of the following operations.

- Highlight an item by using , and press , or **OK**.
- Press **6**.



(5) Select a desired language.

Select an item by one of the following operations.

- Highlight an item by using , and press  or **OK**.
- Press the digit key of desired number, and press  or **OK**.  
For example, press **1** + **5** to select **15** Spanish.

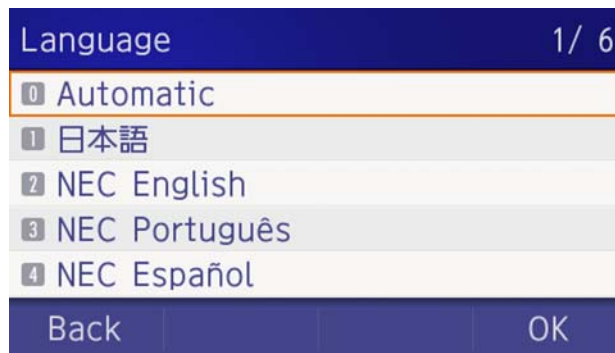

**TIP** Default setting is **Automatic**.

**TIP** When selecting **Automatic**, follow the setting on the System. For the setting on the System, contact to the System Administrator.



**TIP** The enabled item is highlighted.

## Set Wallpaper

The following explains how to set wallpaper.

- (1) Display the **Menu** screen, select **Setting**.
- (2) Select **1** **User Setting**.

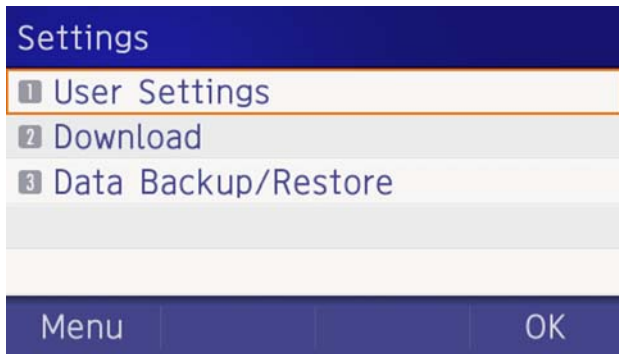

Select an item by one of the following operations.

- Highlight an item by using , and press , or **OK**.
- Press **1**.



(3) Select **3 Display**.

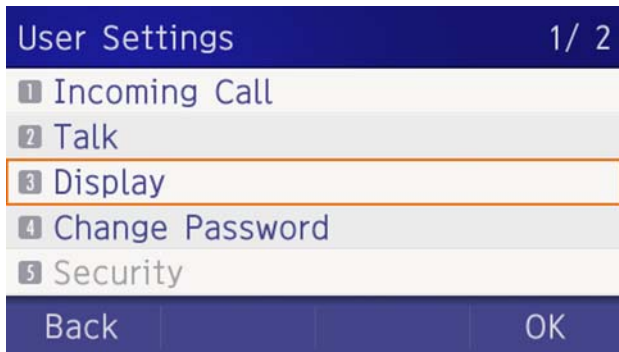

Select an item by one of the following operations.

- Highlight an item by using , and press , or **OK**.
- Press **3**.



(4) Select **7 Advanced**.

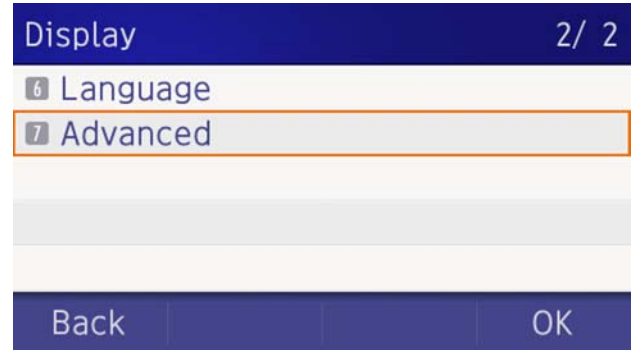

Select an item by one of the following operations.

- Highlight an item by using , and press , or **OK**.
- Press **7**.



(5) Select **1 Wallpaper**.



Select an item by one of the following operations.

- Highlight an item by using , and press , or **OK**.
- Press **1**.



(6) Choose either **1** **Default** or **2** **Download**.

Select an item by one of the following operations.

- Highlight an item by using , and press  or **OK**.
- Press **1** or **2**, and press  or **OK**.

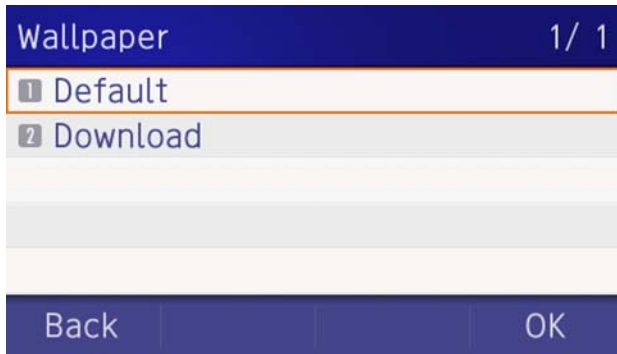

*Note:* When choosing **Download**, the wallpaper file must be downloaded in advance. If there is no downloaded file, the wallpaper is default.

- TIP** Default setting is **Default**.
- TIP** The enabled item is highlighted.



### Set Character Font Color

The following steps show how to set the displayed character color on the LCD.

*Note:* Font characters are displayed in LCD 4-line display area.

- (1) Display the **Menu** screen, select **Setting**.
- (2) Select **1** **User Setting**.

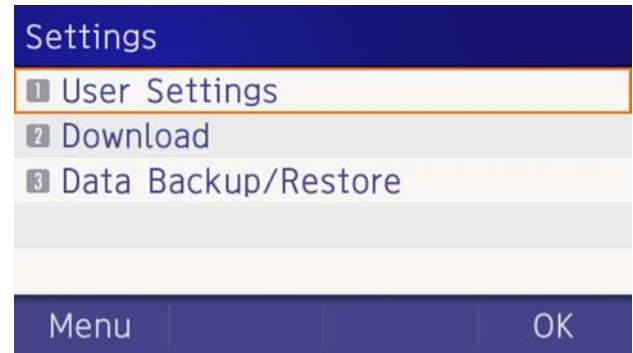

Select an item by one of the following operations.

- Highlight an item by using , and press , or **OK**.
- Press **1**.



(3) Select **3** **Display**.

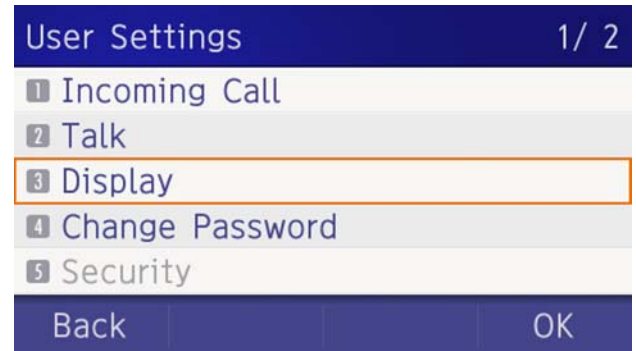

Select an item by one of the following operations.

- Highlight an item by using , and press , or **OK**.
- Press **3**.



(4) Select **7 Advanced**.

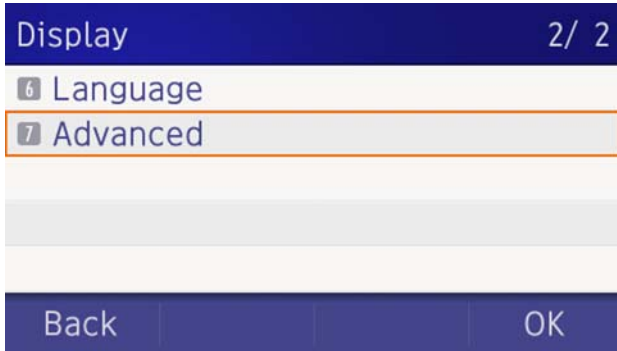

Select an item by one of the following operations.

- Highlight an item by using , and press ,  or **OK**.
- Press **7**.



(5) Select **2 Font Color**.

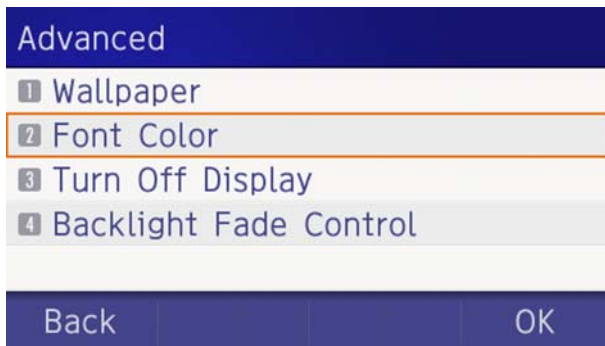

Select an item by one of the following operations.

- Highlight an item by using , and press ,  or **OK**.
- Press **2**.



(6) Select a desired color.

Select an item by one of the following operations.

- Highlight an item by using , and press  or **OK**.
- Press the digit key of desired number, and press  or **OK**.

For example, press **1** + **5** to select **15 Color 15**.

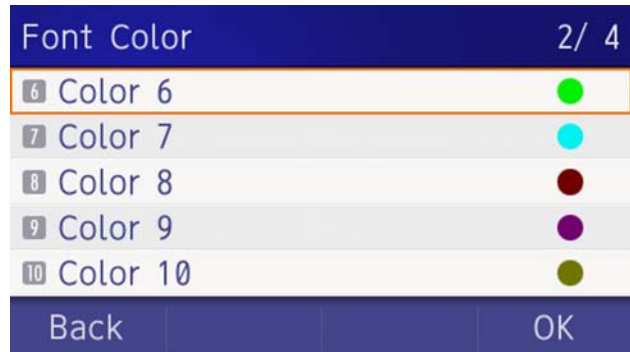
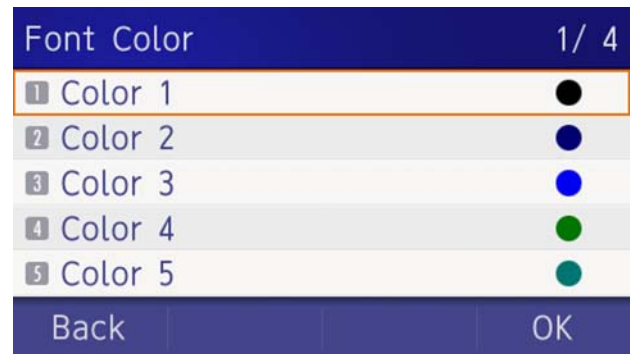



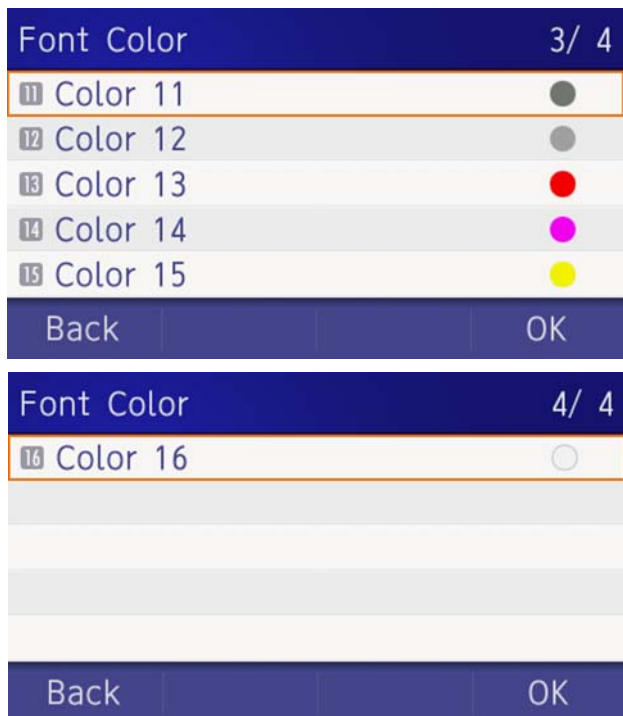

**Table of Font Color**

NO.	Color Name	RGB code
1	Color 1	0x000000
2	Color 2	0x000080
3	Color 3	0x0000FF
4	Color 4	0x008000
5	Color 5	0x008080
6	Color 6	0x00FF00
7	Color 7	0x00FFFF
8	Color 8	0x800000
9	Color 9	0x800080
10	Color 10	0x808000
11	Color 11	0xA0A0A0
12	Color 12	0xC0C0C0
13	Color 13	0xFF0000
14	Color 14	0xFF00FF
15	Color 15	0xFFFF00
16	Color 16	0xFFFFFFFF

**TIP** The color of the character corresponds to an actual display color on the screen of the color selection.

**TIP** Default setting is **Color 16**.



**TIP** The enabled item is highlighted.

## Set Turn Off Display

The Turn off Display works after the telephone is idle for a certain period of time. The following shows how to set Turn off Display.

- (1) Display the **Menu** screen, select **Setting**.
- (2) Select **1 User Setting**.

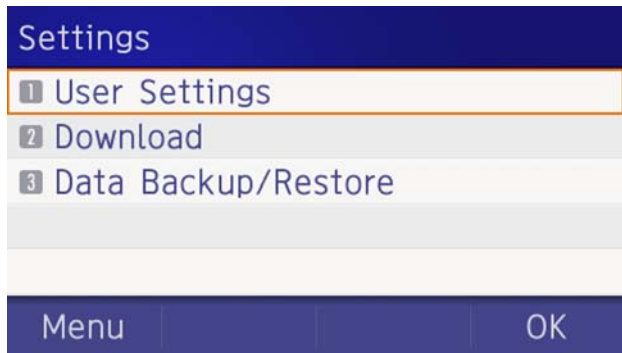

Select an item by one of the following operations.

- Highlight an item by using , and press , or **OK**.
- Press **1**.



- (3) Select **3 Display**.

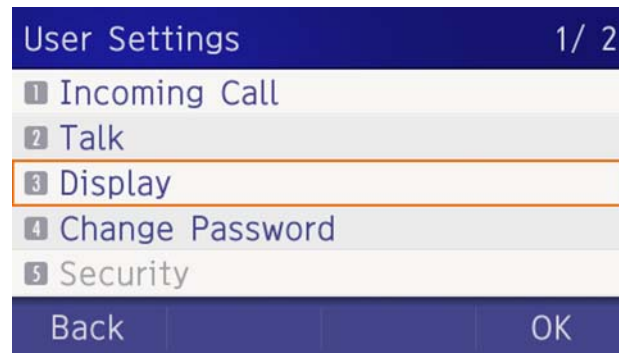

Select an item by one of the following operations.

- Highlight an item by using , and press , or **OK**.
- Press **3**.



- (4) Select **7 Advanced**.

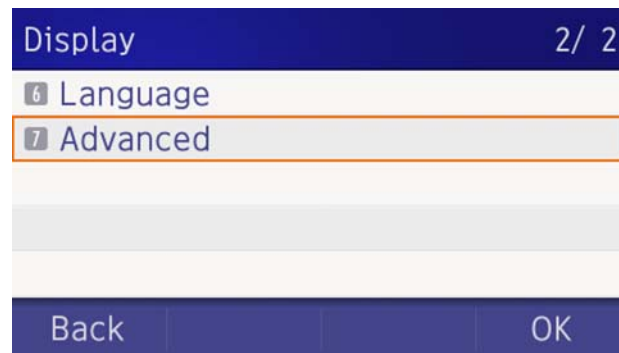

Select an item by one of the following operations.

- Highlight an item by using , and press , or **OK**.
- Press **7**.



(5) Select **3 Turn Off Display**.



Select an item by one of the following operations.

- Highlight an item by using , and press , or **OK**.
- Press **3**.



(6) Choose **1 Turn Off Display Mode**.

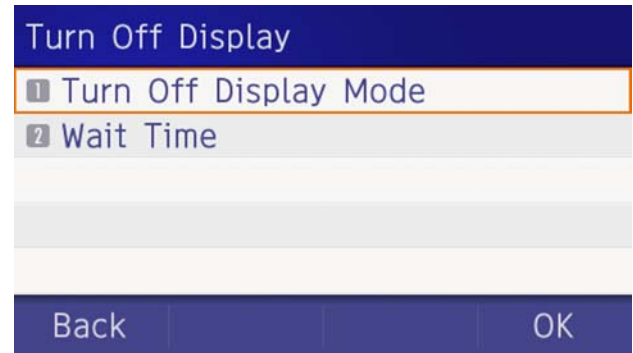

Select an item by one of the following operations.

- Highlight an item by using , and press , or **OK**.
- Press **1**.



(7) Select **1 Disable**, **2 Enable** or **3 App priority**.

Select an item by one of the following operations.

- Highlight an item by using , and press  or **OK**.
- Press **1**, **2** or **3**, and press  or **OK**.

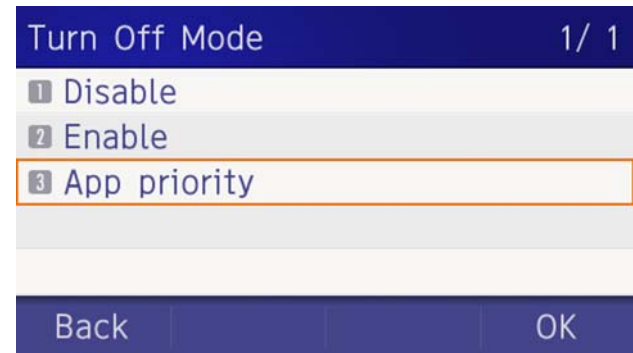

**Note:** You can set a screen saver to an external application. For details, contact the System Administrator.

**TIP**

If you select **App priority**, the screen saver is set to an external application. When the external application orders the terminal display to turn off while the screen saver activates, the display will be turned off.

**TIP**

The enabled item is highlighted.

- (8) The display returns to the Turn Off Display screen. When **2 Enable** is selected at Step 7, Choose **2 Wait Time**.

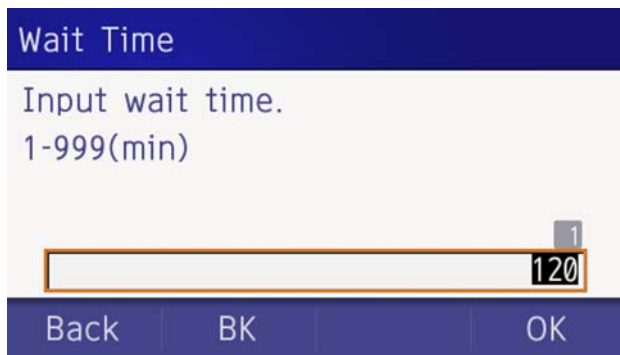

- (9) Input **Wait Time** to turn off the display (1-999 min) and press  or **OK**.

**TIP**



When **App priority** is selected for **Turn Off Display Mode**, if the external application does not give instructions to turn off the display, the setting of **Wait Time** will be invalid.

**TIP**

Default value is **180 min**.

### Set Backlight Fade Control

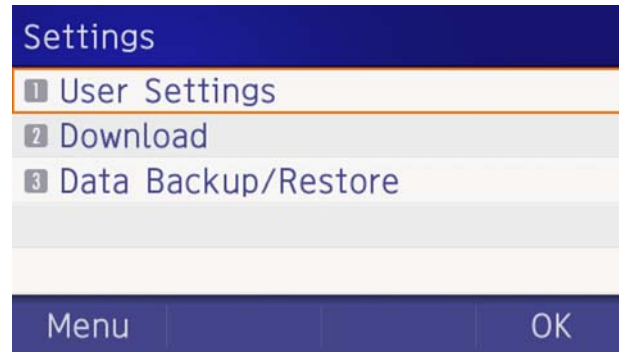

The following explains how to set Backlight Fade Control. When you set Backlight Fade Control as **Enable**, you can turn on/off the LCD smoothly.

- (1) Display the **Menu** screen, select **Setting**.
- (2) Select **1 User Setting**.  
Select an item by one of the following operations.
  - Highlight an item by using , and press , or **OK**.
  - Press **1**.



- (3) Select **3 Display**.

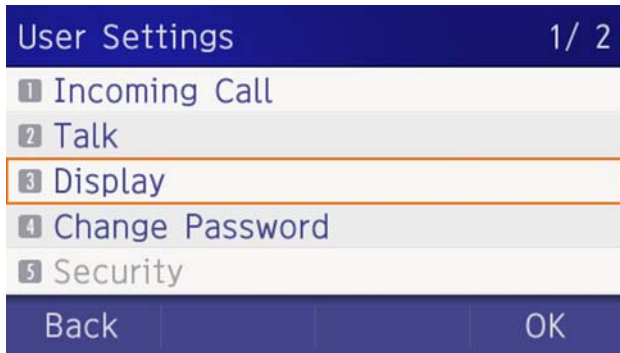

Select an item by one of the following operations.

- Highlight an item by using , and press , or **OK**.
- Press **3**.



(4) Select **7 Advanced**.

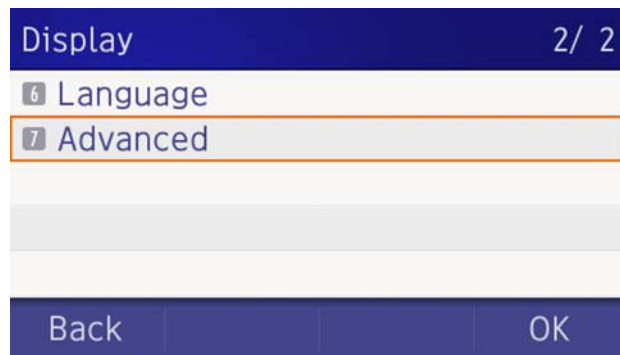

Select an item by one of the following operations.

- Highlight an item by using , and press , or **OK**.
- Press **7**.



(5) Select **4 Backlight Fade Control**.

Select an item by one of the following operations.

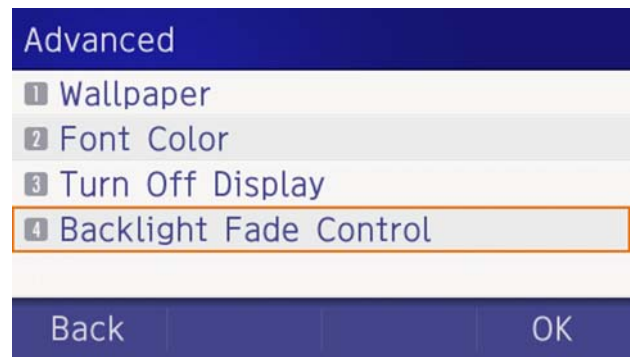

- Highlight an item by using , and press , or **OK**.

- Press **4**.



(6) Choose either **1 Disable** or **2 Enable**.

Select an item by one of the following operations.

- Highlight an item by using , and press  or **OK**.
- Press **1** or **2**, and press  or **OK**.



**TIP** | Default value is **Enable**.



## Change Password

To change an existing password, follow the procedure below. This password is used for the following occasions.

- To lock/unlock the telephone.
- To delete the directory data.
- To reset the telephone settings.

- (1) Display the **Menu** screen, select **Setting**.
- (2) Select **1 User Setting**.

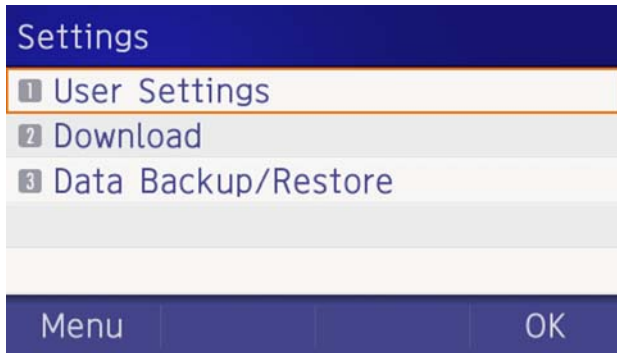

Select an item by one of the following operations.

- Highlight an item by using , and press , or **OK**.
- Press **1**.



- (3) Select **4 Change Password**.

Select an item by one of the following operations.

- Highlight an item by using , and press , or **OK**.

- Press **4**.

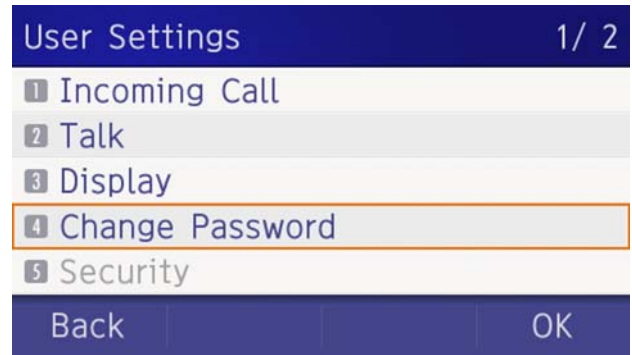

- (4) Enter the old password.

After entering the old password, press  or **Set**.

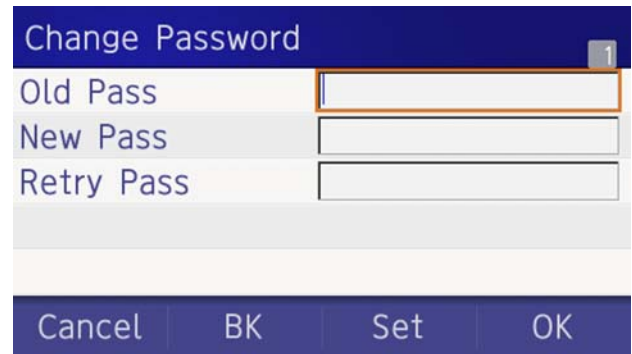

**Note:** The default password is **0000**. When changing the password for the first time, enter **0000** as the old password.

- (5) Enter the new password.

After entering the new password, press  or **Set**.

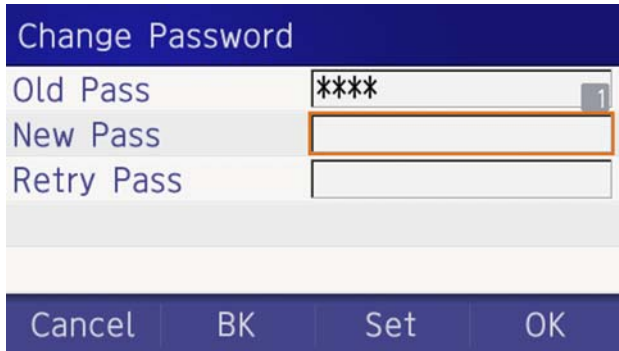

Change Password

Old Pass \*\*\*\* 1

New Pass

Retry Pass

Cancel BK Set OK

- (6) Enter the new password again.

After entering the retry password, press  or **OK**.

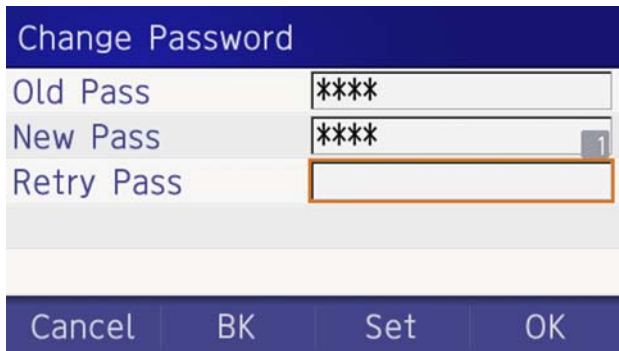

Change Password

Old Pass \*\*\*\*

New Pass \*\*\*\* 1

Retry Pass

Cancel BK Set OK

**Note:** A maximum of 32 digits (0-9, \* and #) can be used when setting a new password.

- (7) When the password entry completes successfully, the display changes as follows.

○ Press  or **OK**.

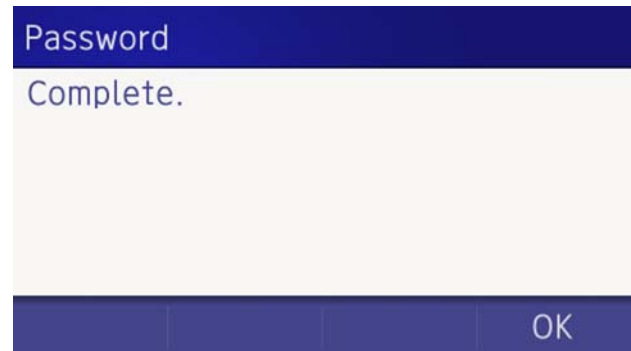

Password

Complete.

OK

**TIP**

When the password entry ends in failure, the following error message is issued. In that case, press **OK** and make a retry.

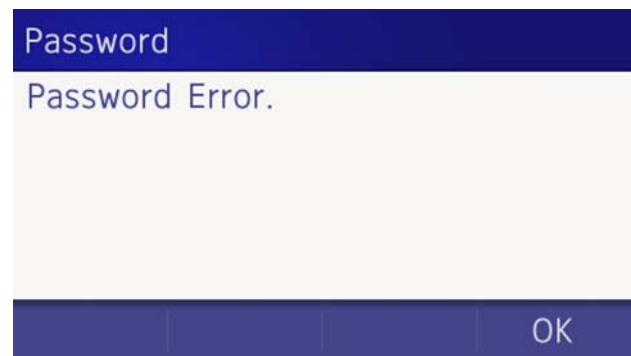

Password

Password Error.



OK

## Set Usability

The procedure below shows how to set the operation of Home key while pop-up window is displayed.

- (1) Display the **Menu** screen, select **Setting**.
- (2) Select **1** **User Setting**.

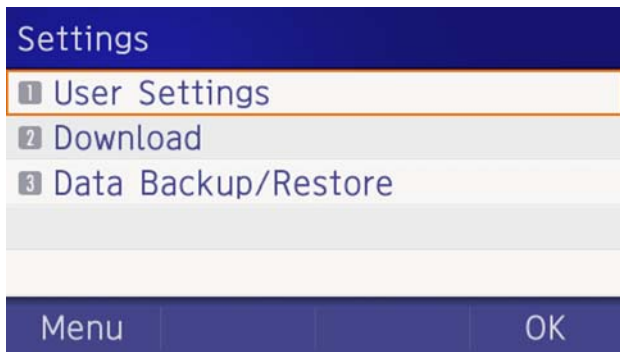

Select an item by one of the following operations.

- Highlight an item by using , and press , or **OK**.
- Press **1**.



- (3) Select **6** **Usability**.

Select an item by one of the following operations.

- Highlight an item by using , and press , or **OK**.
- Press **6**.



- (4) Ensure **1** **Help Key Mode** is specified.

Select an item by one of the following operations.

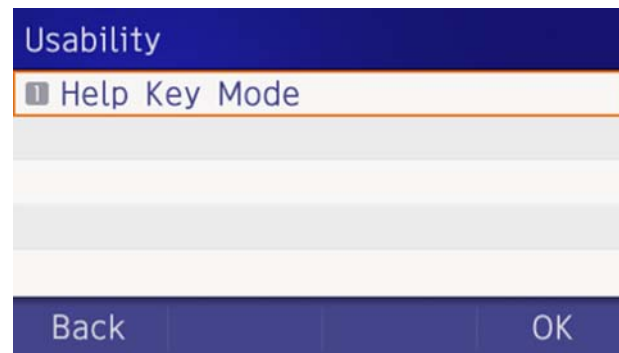

- Press , or **OK**.
- Press **1**.





(5) Choose the desired **Help** key mode.

**Note:** Select an item by one of the following operations.

- Highlight an item by using , and press  or **OK**.
- Press **①** or **②**, and press  or **OK**.

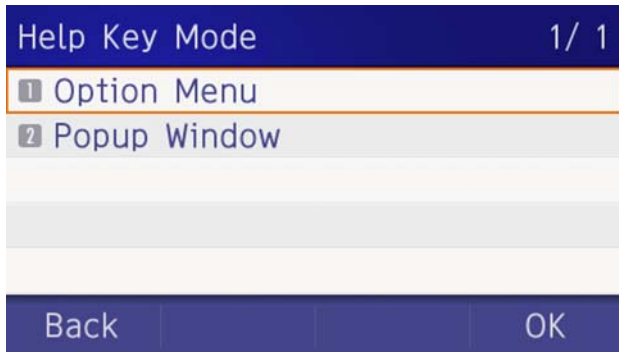



No.	Item	Description
1	Option Menu	Set the <b>Home</b> key which displays option menu.
2	Pop-up Window	Set the <b>Home</b> key that displays pop-up window.

### Reset Telephone Settings

The following explains how to clear personal data off the telephone.

- (1) Display the **Menu** screen, select **Setting**.
- (2) Select **① User Setting**.

Select an item by one of the following operations.

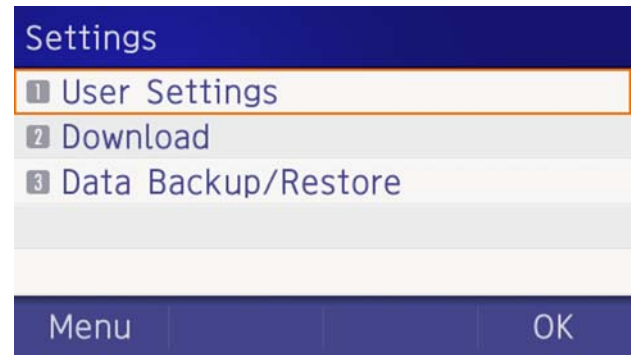

- Highlight an item by using , and press , or **OK**.

- Press **①**.



(3) Select **① Setting Reset**.

Select an item by one of the following operations.

- Highlight an item by using , and press , or **OK**.
- Press **①**.

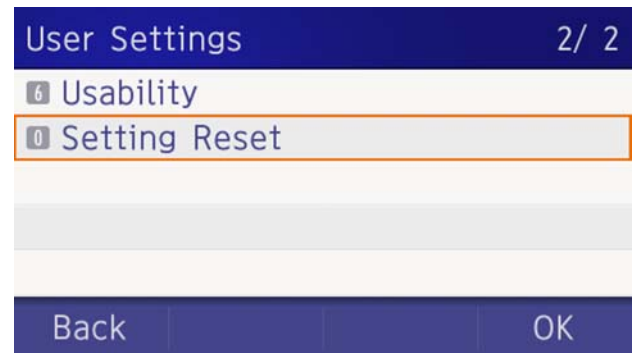

- (4) Enter the password.

After entering the password, press  or **OK**.

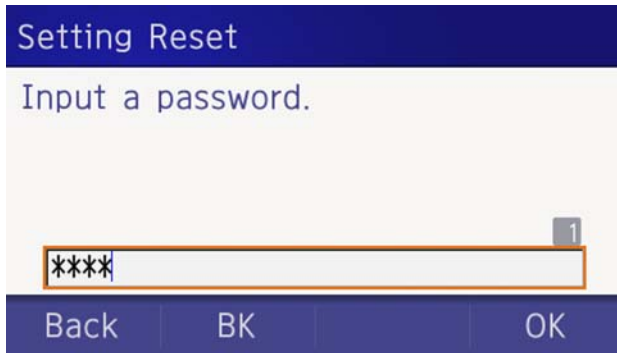

- (5) When the password entry completes successfully, the display changes as follows.

Press  or **OK** to clear the personal data off the telephone.

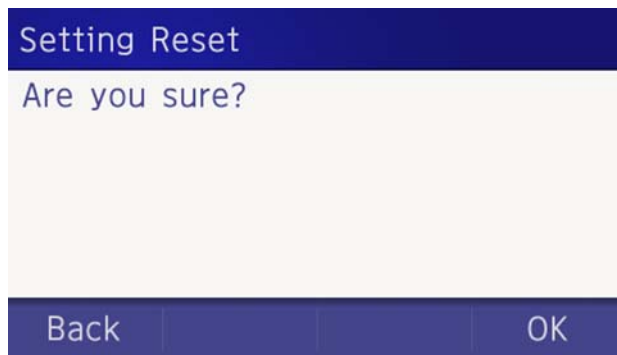

**TIP**

When the password entry ends in failure, the following error message is issued. In that case, press **OK** and make a retry.

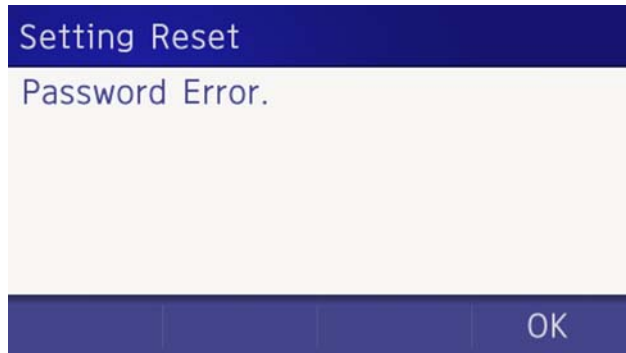

### Download a File

You can download files for Music on Hold, Ringer Tone, and Wallpaper.

When downloading these files, the DT930 needs to be connected to the network that has FTP/TFTP/HTTPS server.

*Note:* For details on the FTP/TFTP/HTTPS service, contact the System Administrator.

Before starting the download, the IP Address of the FTP/TFTP/HTTPS Server must be entered from DT930.

- (1) Set up the FTP/TFTP/HTTPS server.

<FTP server>

Put the downloading file into the designated directory (for Windows IIS, the default is "C:\inetpub\ftproot") of the FTP server.

<TFTP server>

Put the downloading file into a desired directory of TFTP server and specify it as the directory for downloading.



<HTTPS server>

Put the downloading file into a desired directory of the HTTPS server and specify the directory for downloading.

**Note:** Refer to the DT Resource Manual for HTTPS server.

- (2) Display the **Menu** screen, select **Setting**.
- (3) Select **2 Download**.

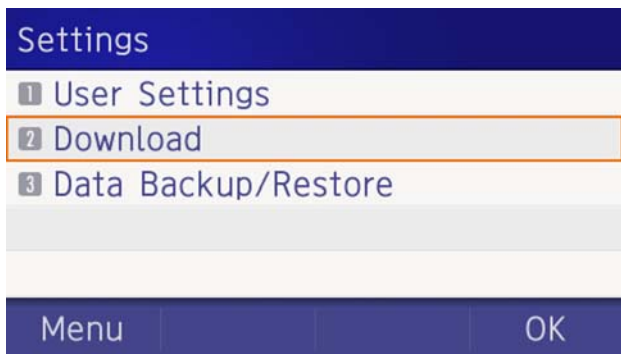

Select an item by one of the following operations.

- Highlight an item by using , and press , or **OK**.
- Press **2**.



- (4) Select **3 Protocol**.

Select an item by one of the following operations.

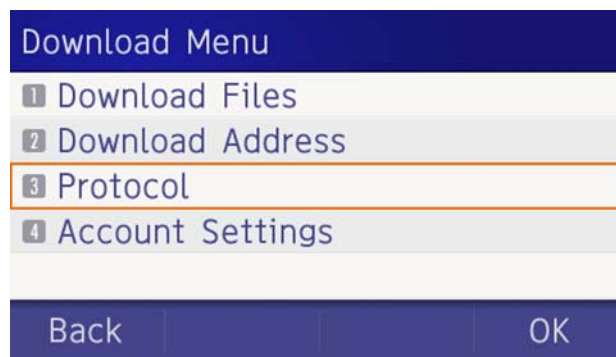

- Highlight an item by using , and press , or **OK**.

- Press **3**.



- (5) Choose a protocol used by the server which stores the download file.

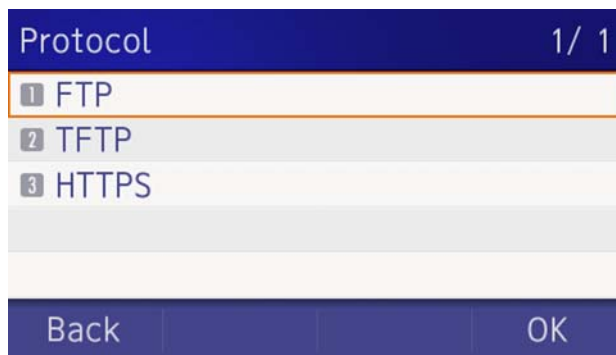

Select an item by one of the following operations.

- Highlight an item by using , and press  or **OK**.
- Press **1**, **2** or **3**, and press  or **OK**.





- (6) The display returns to the **Download Menu** screen.
- If **1** **FTP** is selected here, continue with STEP 7.
- If **2** **TFTP** is selected here, proceed to **STEP 15**.
- If **3** **HTTPS** is selected here, proceed to **STEP 7**.
- (7) Select **4** **Account Settings**.

Select an item by one of the following operations.

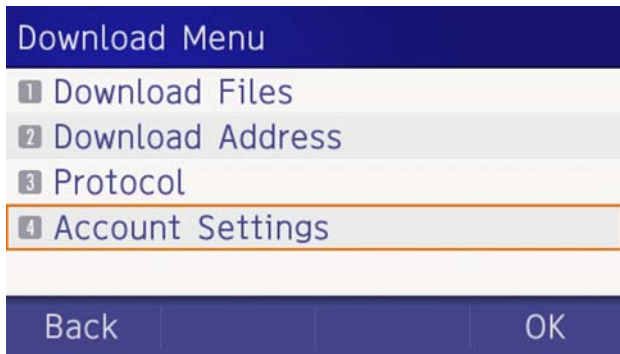
- Highlight an item by using , and press , or **OK**.
- Press **4**.



- (8) Select **1** **User ID**.
- Select an item by one of the following operations.
- Highlight an item by using , and press , or **OK**.
  - Press **1**.

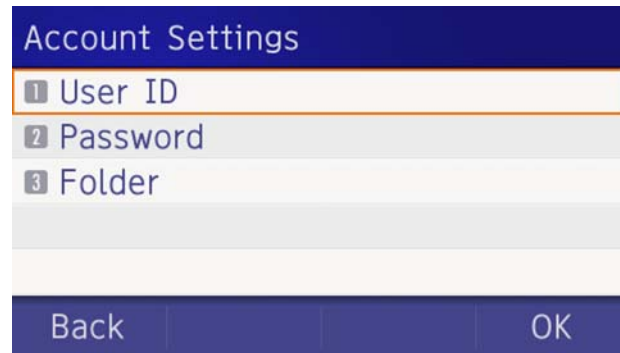

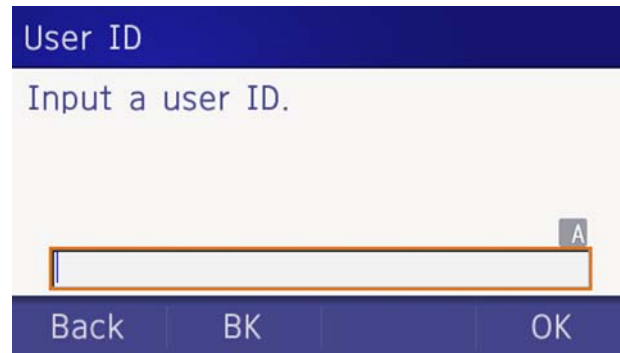

- (9) Enter a **User ID**.
- Enter a User ID by pressing digit keys, and press  or **OK**.



**TIP** For details on character entry method, see [How to Input Characters](#).

- (10) The display returns to the **Account Settings** screen. Select **2 Password**.

Select an item by one of the following operations.

- Highlight an item by using , and press , or **OK**.
- Press **2**.

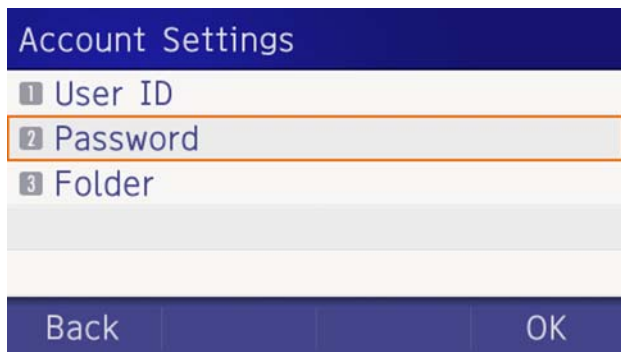

- (11) Enter a password.

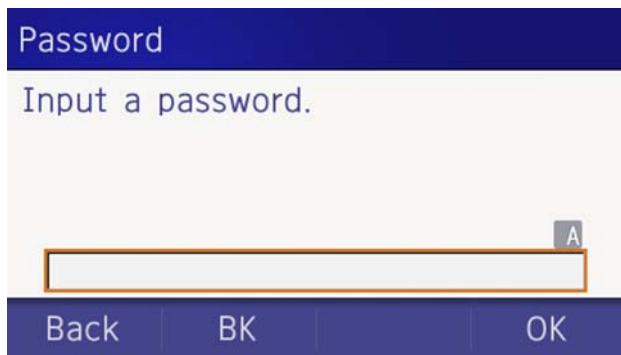

Enter a User ID by pressing digit keys, and press  or **OK**.



**TIP** For details on character entry method, see [How to Input Characters](#).

- (12) The display returns to the **Account Settings** screen. Select **3 Folder**.

Select an item by one of the following operations.

- Highlight an item by using , and press , or **OK**.
- Press **3**.

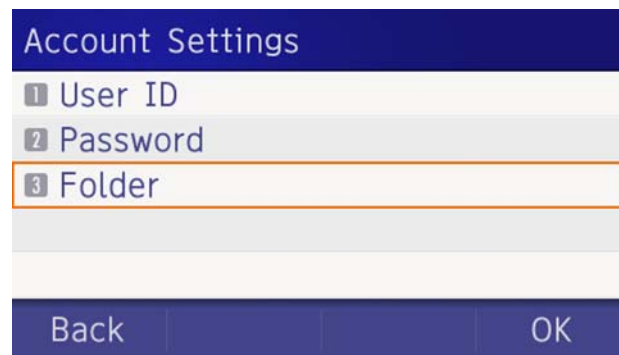

(13) Enter the directory where the download file is stored.

After entering the directory, press  or **OK**.

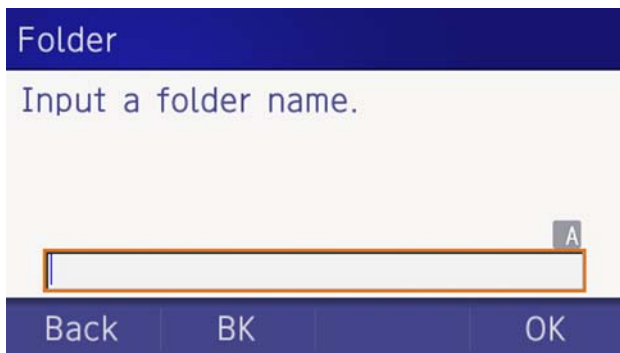

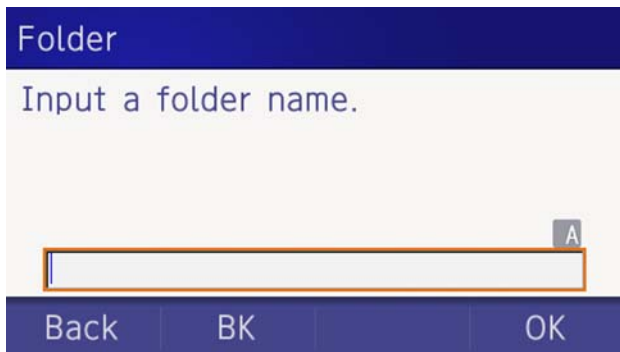

**TIP** For details on character entry method, see [How to Input Characters](#).

(14) The display returns to the **Account Settings** screen. Press  or **Back** to display the **Download Menu** screen.



(15) Select **2 Download Address**.

Select an item by one of the following operations.

- Highlight an item by using , and press ,  or **OK**.
- Press **2**.

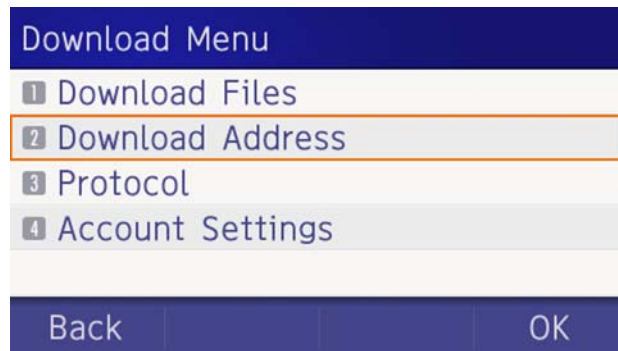

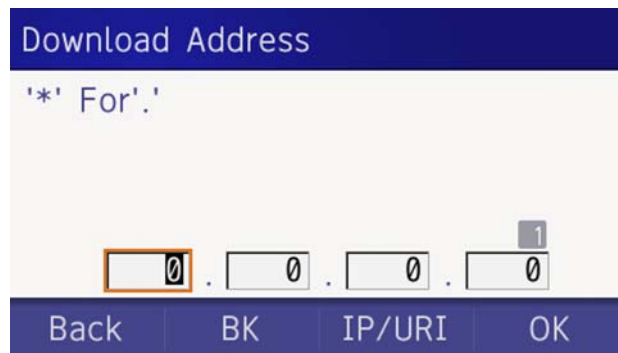

(16) Enter an **IP address** of the FTP/TFTP/HTTPS server which stores the download file.

For example, to set the IP address of 10.41.208.205, enter 10\*41\*208\*205 [separate with an asterisk (\*)].



(17) The display returns to the **Download Menu** screen. Select **1 Download Files**.

Select an item by one of the following operations.

- Highlight an item by using , and press ,  or **OK**.
- Press **1**.

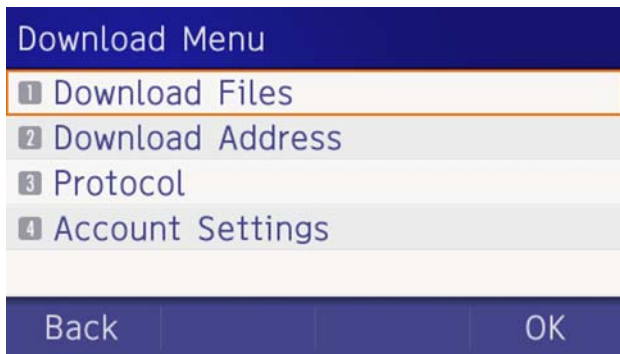



(18) Select file to be downloaded.

When downloading a file for Music on Hold	Select <b>1 Hold Music</b> and go to <b>STEP 20</b> .
When downloading a file for ringer tone	Select <b>2 Ring Tone</b> and go to <b>STEP 19</b> .
When downloading a file for Wallpaper	Select <b>4 Directory</b> and go to <b>STEP 20</b> .

(19) When **2 Ring Tone** is selected at **STEP 18**, the following **Ring Tone** screen is displayed. Select either **1 Music Ring 1**, **2 Music Ring 2** or **3 Music Ring 3**.

Select an item by one of the following operations.

- Highlight an item by using , and press ,  or **OK**.
- Press **1** - **3**.

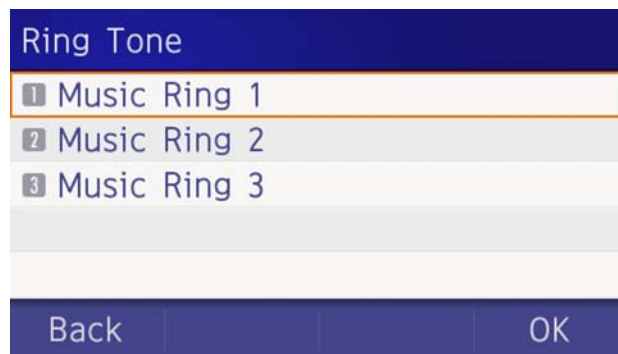

(20) The default file name will be displayed.

When downloading a file for Music on Hold, the default file name is **MOH.wav**.

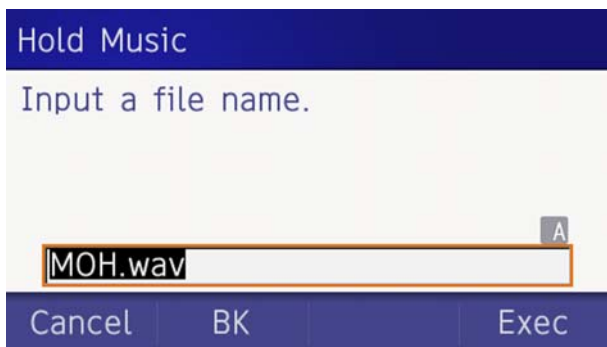

File Format	Maximum Size
PCM $\mu$ -law 8kHz/s wav.	under 32 seconds

When downloading a file for ringer tone, the default file name is **Melody1/2/3/.wav**.

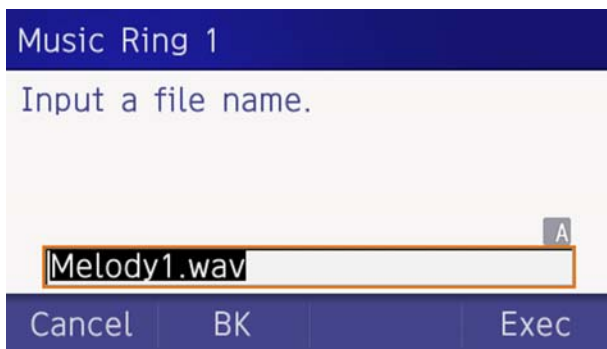

File Format	Maximum Size
PCM $\mu$ -law 8kHz/s wav.	under 32 seconds

When downloading a file for Wallpaper, the default file name is **WallPaper.bmp**.

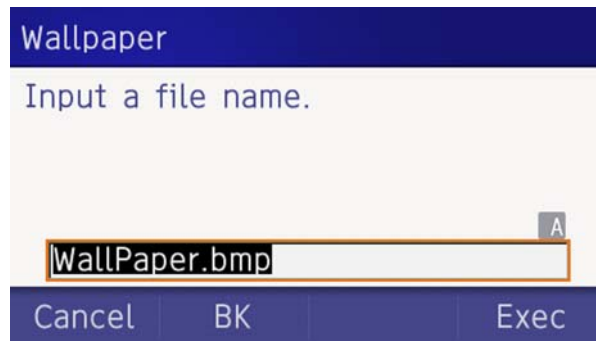

File Format	Maximum Size
bmp/jpg/gif/png	480 X 272 Pixels

If changing the file name, continue with [STEP 21](#).

If not changing the file name, proceed to [STEP 22](#).

(21) Press **BK** once to delete the default file name and enter a new file name by using the digit keys.

*Note:* A maximum of 20 characters (“0-9”, “A-Z”, “a-z”, “\*”, “#”, “.”, “-” or “\_”) can be entered as a file name.

**TIP** For details on character entry method, see [How to Input Characters](#).

**TIP** To delete an entered character, press **BK**.



- (22) Press  or **Exec** to start the downloading process.

While downloading a file, the LCD displays “Downloading...” first and “Saving...”.

*Note:* While “Saving...” is displayed on the LCD, do not to power OFF the DT930.

- (23) When the downloading process completes, the following is displayed.



- (24) The display returns to the **Download Files** screen upon **Exit**.

*Note:* When the downloading process ends in failure, **Downloading Failed!** is displayed on the LCD. Check the following and retry.

Check Points	Actions
Download file is not placed in the specified directory.	Place the download file in the specified directory.
A different file name is specified between DT930 and FTP/TFTP/HTTPS server.	Set the same file name from both DT930 and FTP/TFTP/HTTPS server.
Incorrect IP address of FTP/TFTP/HTTPS server has been entered from the telephone.	Set the proper IP address of FTP/TFTP/HTTPS server.
The power to FTP/TFTP/HTTPS server or network equipment is Off.	Turn On the power.
LAN cable is disconnected.	Reconnect the cable securely.

### Backup Personal Settings

You can backup personal settings of DT930 to FTP/TFTP/HTTPS server. To back up the setting data, the DT930 needs to be connected to the network that has FTP/TFTP/HTTPS server).

*Note:* For details on the XML service, contact the System Administrator.

- (1) Set up the FTP/TFTP/HTTPS server.

<FTP server>

Confirm the designated directory (for Windows IIS, the default is “C:\InetPub\ftproot”) for the backed up file.

<TFTP server>



Specify a desired destination directory for the backed up file.

<HTTPS server>

Specify a desired destination directory for the backed up file.

- (2) Display the **Menu** screen, select **Setting**.
- (3) Select **3 Data Backup/Restore**.

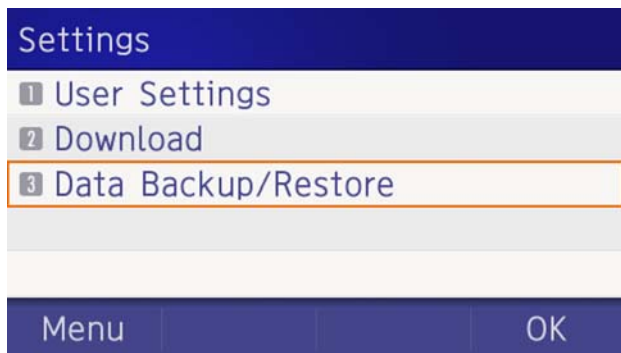

Select an item by one of the following operations.

- Highlight an item by using , and press , , or **OK**.
- Press **3**.



- (4) Select **4 Protocol**.

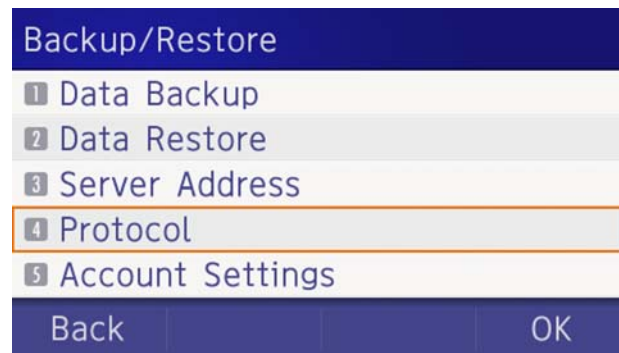

Select an item by one of the following operations.

- Highlight an item by using , and press , , or **OK**.
- Press **4**.



- (5) Choose a protocol used by the destination server.

Select an item by one of the following operations.

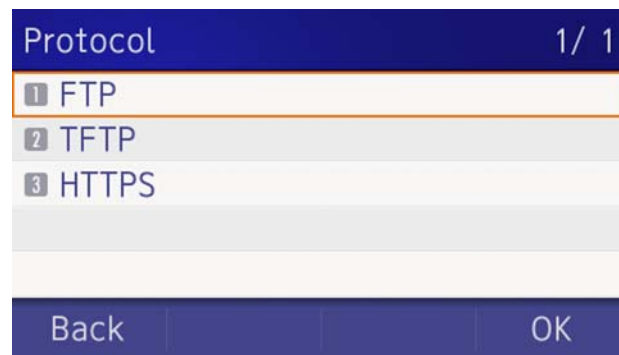

- Highlight an item by using , and press  or **OK**.
- Press **1**, **2**, or **3** and press  or **OK**.



- (6) The display returns to the **Backup/Restore** screen.
- If **1** **FTP** is selected, continue to with **STEP 7**.
- If **2** **TFTP** is selected, proceed to **STEP 14**.
- If **3** **HTTPS** is selected, proceed to **STEP 7**.

- (7) Select **5** **Account Settings**.

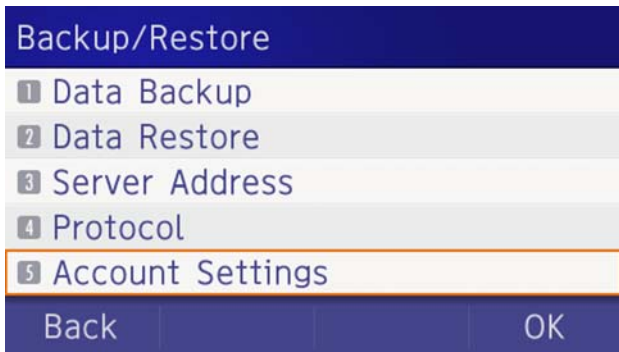

Select an item by one of the following operations.

- Highlight an item by using , and press , or **OK**.
- Press **5**.



- (8) Select **1** **User ID**.

Select an item by one of the following operations.

- Highlight an item by using , and press , or **OK**.
- Press **1**.

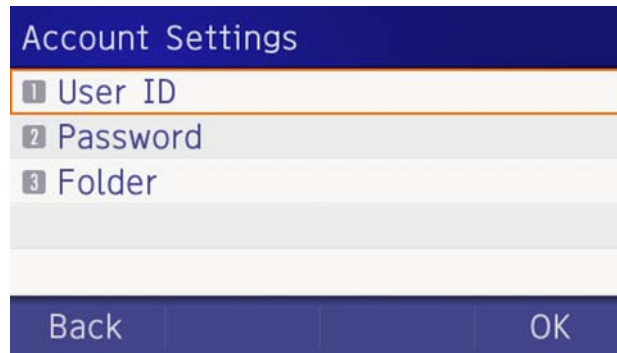

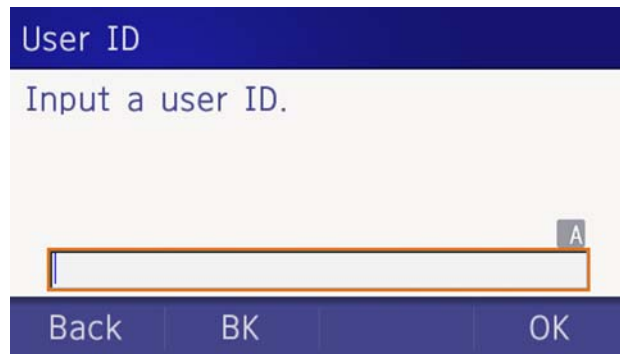

- (9) Enter a **Used ID**.

Enter a User ID by using digit keys, then press  or **OK**.



**TIP** For details on character entry method, see [How to Input Characters](#).

The display returns to the **Account Settings** screen. Select **2 Password**.  
Select an item by one of the following operations.

- Highlight an item by using , and press , or **OK**.
- Press **2**.

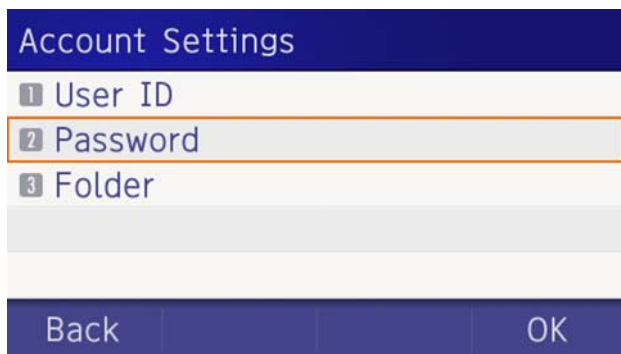

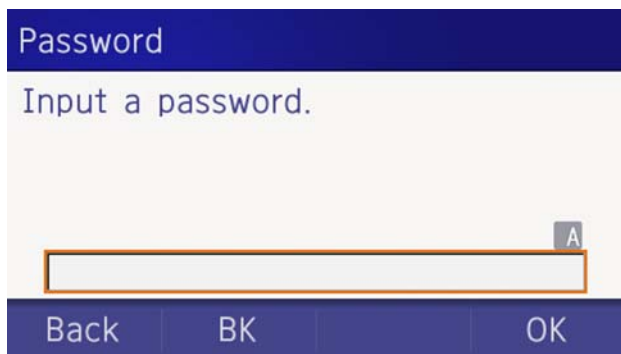

(10) Enter a password.

Enter a password by using digit keys, and press  or **OK**.



(11) The display returns to the **Account Settings** screen. Select **3 Folder**.

Select an item by one of the following operations.

- Highlight an item by using , and press , or **OK**.
- Press **3**.

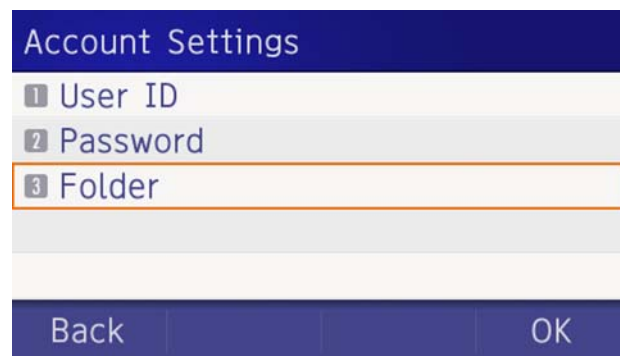

(12) Enter the destination directory of the FTP/HTTPS server.

After entering the directory, press  or **OK**.

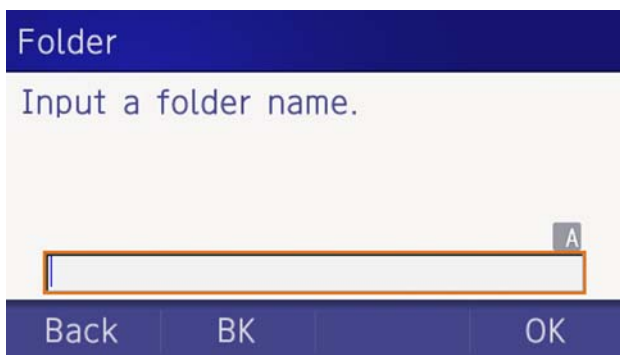

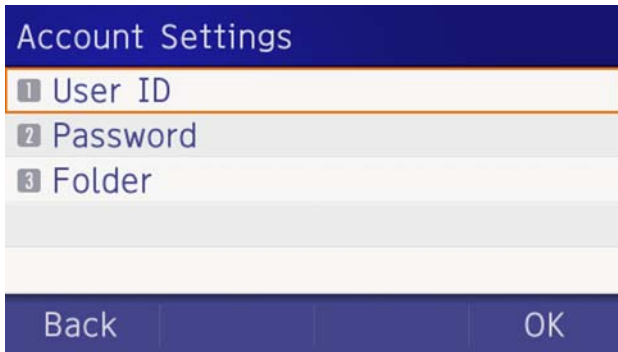

**TIP** For details on character entry method, see [How to Input Characters](#).

- (13) The display returns to the **Account Settings** screen. Press  or **Back** to display the **Backup/Restore** screen.



- (14) Select **3 Server Address**.

Select an item by one of the following operations.

- Highlight an item by using , and press , or **OK**.
- Press **3**.



- (15) Enter an **IP Address** of the destination FTP/TFTP/HTTPS server.

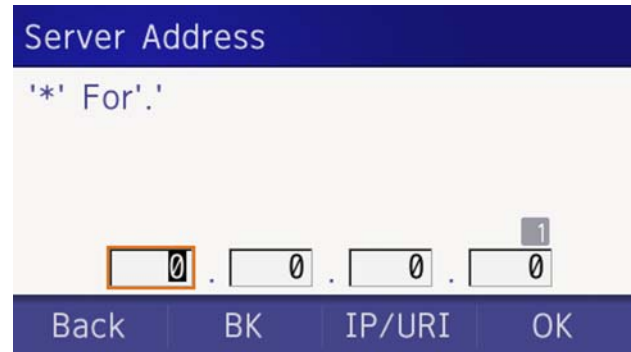

For example, to set the IP address of 10.41.208.205, enter 10\*41\*208\*205 [separate with an asterisk (\*)].



After entering an **IP Address**, press  (**Enter**) or **OK**.

(16) The display returns to the **Backup/Restore** screen. Select **1 Data Backup**.

Select an item by one of the following operations.

- Highlight an item by using , and press , or **OK**.
- Press **1**.



(17) The default file name is displayed as follows:

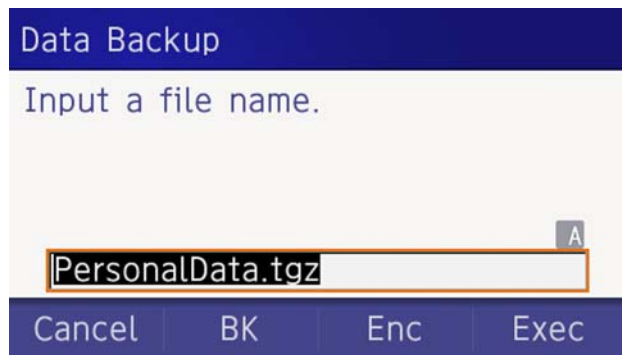

**Note:** Do not change the extension of the backup file. The setting data of the telephone can only be backed up as a.tgz file.

**Note:** A maximum of 20 characters (“0-9”, “A-Z”, “a-z”, “\*”, “#”, “.”, “-” or “\_”) can be entered as a file name.

**TIP** When changing the default file name, press **BK** once to delete the default file name and enter a new file name by using the digits keys.

**TIP** For details on character entry method, see [How to Input Characters](#).

**TIP** To delete an entered character, press **BK**.

(18) Press  or **Exec** to start the data backup.

While making a backup copy, the LCD displays “Uploading...”, and when the data backup completes, LCD displays **Upload Complete!**. If the data backup failed, LCD displays **Upload Failed!**.

(19) After the data backup completes, the display changes to the following:



(20) The display returns to the **Backup/Restore** screen upon **Exit**.

**Note:** When the data backup ends in failure, **Upload Failed!** is displayed on the LCD. Check the following and retry.

Check Points	Actions
Incorrect IP address of FTP/TFTP/HTTPS server has been entered from the telephone.	Set the proper IP address of FTP/TFTP/HTTPS server.
The power to FTP/TFTP/HTTPS server or network equipment is Off.	Turn On the power.
LAN cable is disconnected.	Reconnect the cable securely.

### Restore Personal Settings

User can restore the personal settings of DT930. To download the backup file to the telephone, the DT930 needs to be connected to the network that has FTP/TFTP/HTTPS.

**Note:** For details on the XML service, contact the System Administrator.

Before starting the download, the IP Address of the FTP/TFTP/HTTPS Server must be entered from DT930.

(1) Set up the FTP/TFTP/HTTPS server.

<FTP server>

Put the backup file you want to restore into the designated directory (for Windows IIS, the default is "C:\inetpub\ftproot") of the FTP server.

<TFTP server>



Put the backup file you want to restore into a desired directory of TFTP server and specify it as the directory for downloading.

<HTTPS server>

Put the backup file you want to restore into a desired directory of HTTPS server and specify it as the directory for downloading.

- (2) Display the **Menu** screen, select **Setting**.
- (3) Select **3 Data Backup/Restore**.

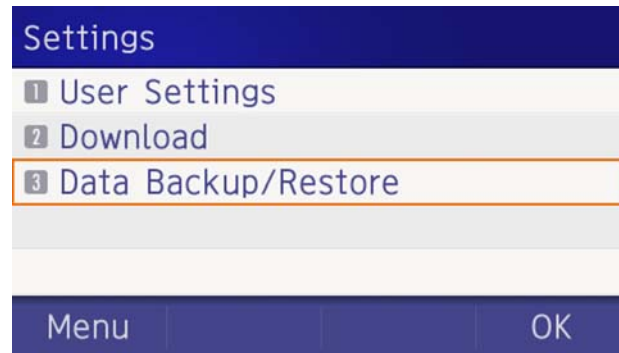

Select an item by one of the following operations.

- Highlight an item by using , and press , or **OK**.
- Press **3**.



(4) Select **4 Protocol**.



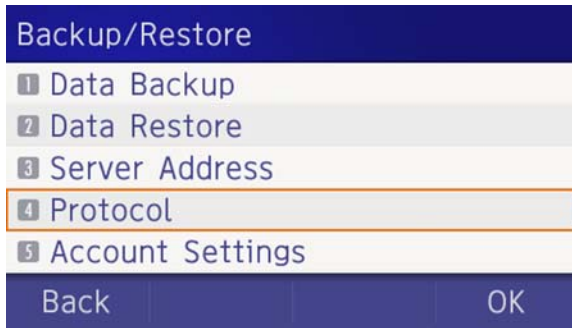

Select an item by one of the following operations.

- Highlight an item by using , and press ,  or **OK**.
- Press **4**.



(5) Choose a protocol used by the server which stores the backup file.

Select an item by one of the following operations.

- Highlight an item by using , and press ,  or **OK**.
- Press **1**, **2** or **3**, and press  or **OK**.

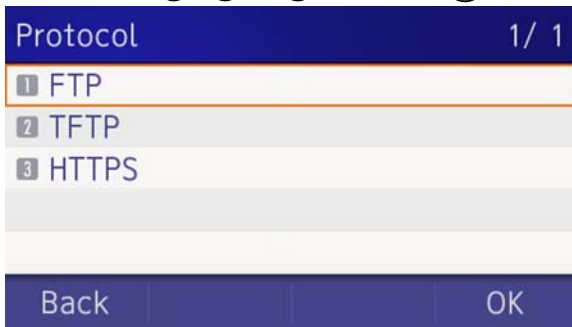

(6) The display returns to the **Backup/Restore** screen.



If **1 FTP** is selected, continue with **STEP 7**.

If **2 TFTP** is selected, proceed to **STEP 15**.

If **3 HTTPS** is selected, proceed to **STEP 7**.

(7) Select **5 Account Settings**.

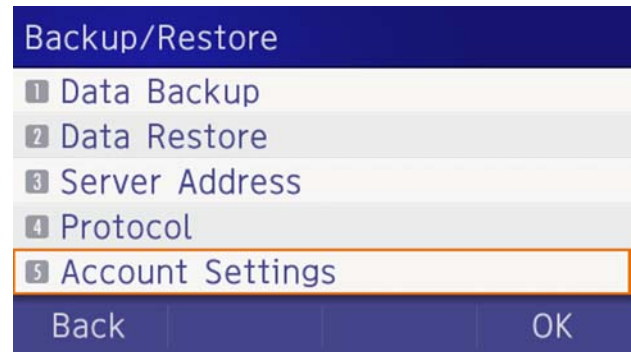

Select an item by one of the following operations.

- Highlight an item by using , and press ,  or **OK**.
- Press **5**.



(8) Select **1 User ID**.

Select an item by one of the following operations.

- Highlight an item by using , and press ,  or **OK**.
- Press **1**.



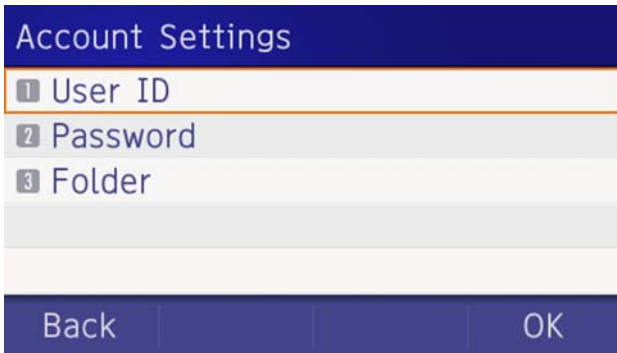

(9) Enter a **User ID**.

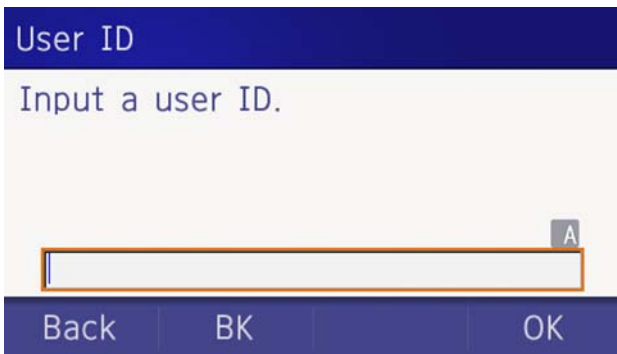

Enter a User ID by using digit keys, then press  or **OK**.



**TIP** For details on character entry method, see [How to Input Characters](#).

(10) The display returns to the **Account Settings** screen. Select **2 Password**.

Select an item by one of the following operations.

- Highlight an item by using , and press ,  or **OK**.
- Press **2**.

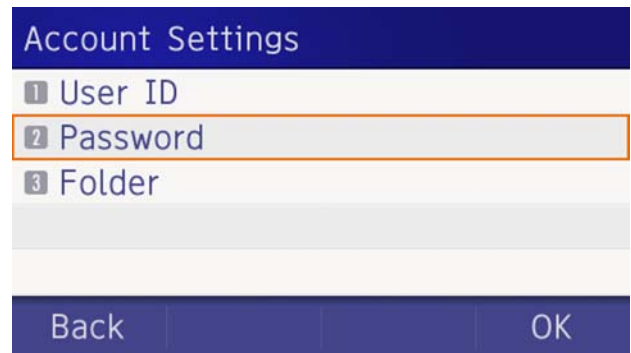

(11) Enter a password.

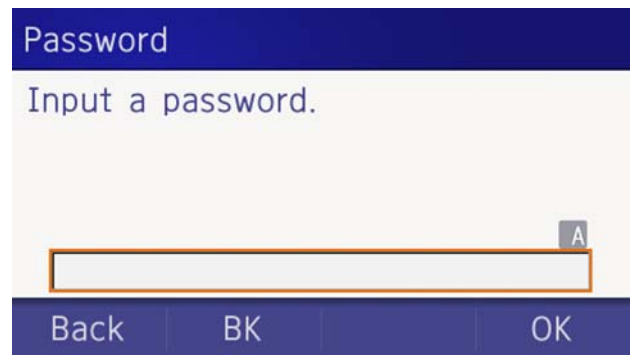

Enter a password by using digit keys, and press  or **OK**.



**TIP** For details on character entry method, see [How to Input Characters](#).

(12) The display returns to the **Account Settings** screen. Select **3** **Folder**.

Select an item by one of the following operations.

- Highlight an item by using , and press ,  or **OK**.
- Press **3**.

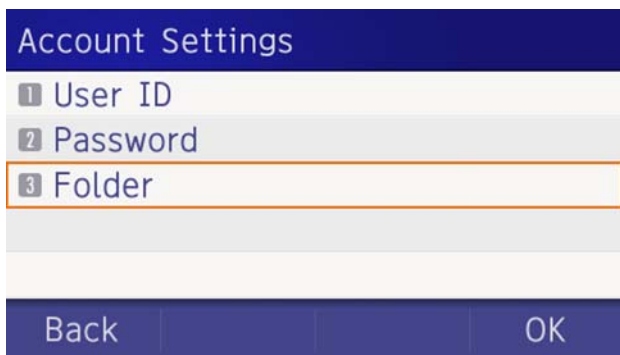

(13) Enter the directory where the backup file is stored.

Enter the directory and press  or **OK**.

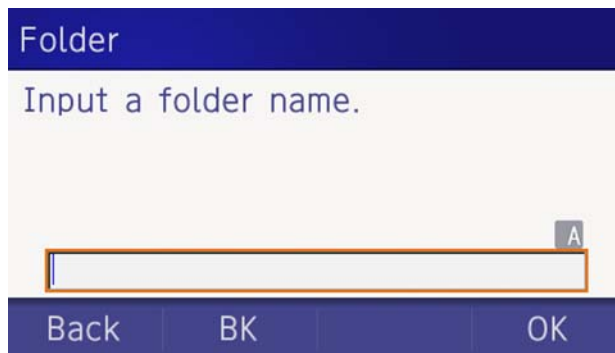

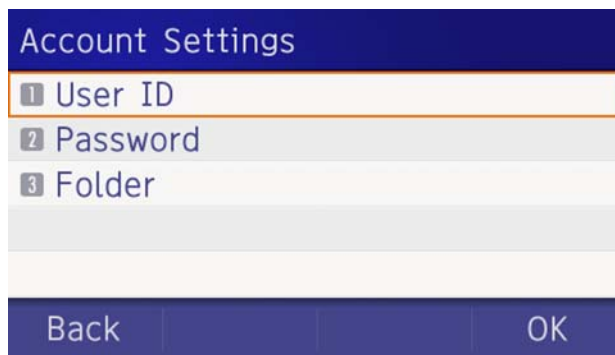

**TIP** For details on character entry method, see [How to Input Characters](#).

(14) The display returns to the **Account Settings** screen. Press  or **Back** to display the **Backup/Restore** screen.



(15) Select **3 Server Address**.

Select an item by one of the following operations.

- Highlight an item by using , and press , or **OK**.
- Press **3**.



(16) Enter an IP Address of the FTP/TFTP/HTTPS server which stores the backup file.

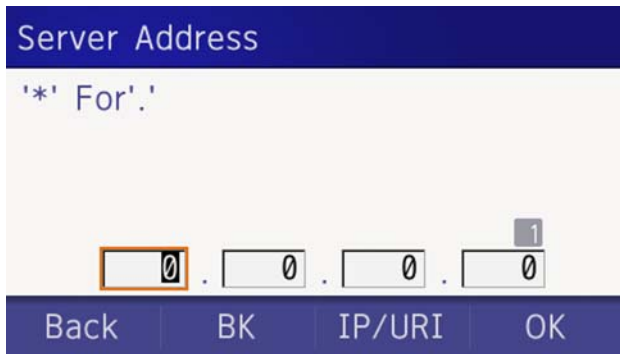

For example, to set the IP address of 10.41.208.205, enter 10\*41\*208\*205 [separate with an asterisk (\*)].



- After entering an IP address, press  or **OK**.

(17) The display returns to the **Backup/Restore** screen. Select **2 Data Restore**.

Select an item by one of the following operations.

- Highlight an item by using , and press , or **OK**.
- Press **2**.



(18) The default name is displayed as follows:

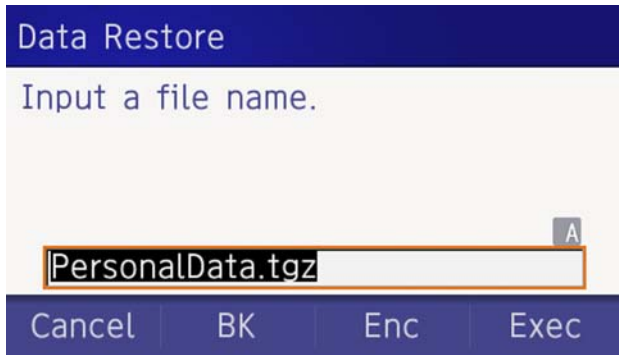

**Note:** Do not change the extension (.tgz) of the backup file. If the extension is changed, the file cannot be restored properly.

**Note:** A maximum of 20 characters ("0-9", "A-Z", "a-z", "\*", "#", ".", "-", or "\_") can be entered as a file name.

- TIP** When changing the default file name, press **BK** once to delete the default file name and enter a new file name by using the digits keys.
- TIP** For details on character entry method, see [How to Input Characters](#).
- TIP** To delete an entered character, press **BK**.

(19) Press  or **Exec** to start restoring the backup data to the telephone.

While downloading the backup data, the LCD displays "Downloading..." first and "Saving...".

**Note:** Do not power OFF the DT930 while "Saving..." is displayed on the LCD.

(20) After the download process completes, the display changes to the following:



# 4. OUTLINE - PORTAL

This chapter explains the outline of a telephone in the Portal Mode.

## Telephone Startup

The telephone displays the screen that is set as the home screen. The home screen can be set to either the Favorite screen/Call screen/Line screen. In addition, when the home URL has been set, the telephone displays the screen obtained from the URL. For details, refer to [Screen When the Phone Starts](#).

## Favorite Screen

Calls can be easily made using registered shortcuts of extensions or outside lines. The following explains about each display area. (The figure displayed is an example of when the shortcuts are registered.)

When the dial button is pressed or an incoming call is received, the Call screen is automatically displayed for telephone operations.



You can also manually return to the Favorite screen to continue the operation. However, the Hold button cannot be used. Switch to the Call screen when operating the phone.

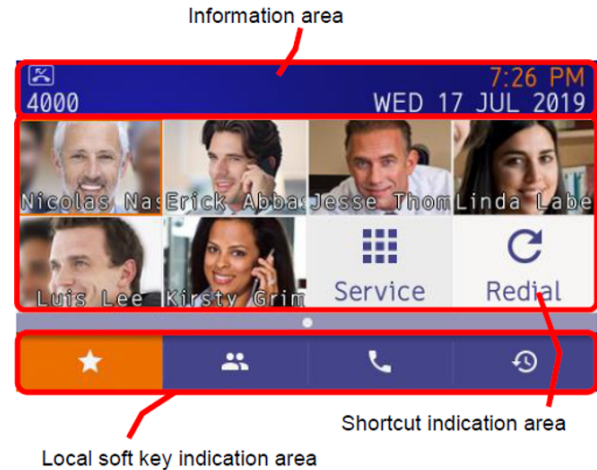

## Information Area

The following displays items in the Information area.

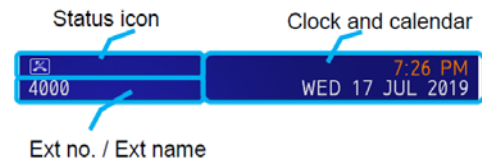





## Status Icon

When there is a new voice mail message or a missed call, an icon is shown in the icon information area.



See below for the meaning of the indicated icons.

Icon	Name	Description
	Missed Call	This icon appears when there is a missed call. Once you check the missed call, this icon will disappear.
	Voice Mail Arrival	This icon provides notification of incoming Voice Mail. Once you check the mail, this icon will disappear.
	Encryption	This icon appears when the conversation is encrypted.
	Power Save	This icon appears when the terminal is in power save mode.
	Headset	This icon appears when the headset is in use.



### Power save icon

Power save mode is set by initial system settings. For details, contact the system administrator.

## Ext No./Ext Name

**Ext no.** is the extension number assigned to the terminal.

If the Phonebook is downloaded, **Ext name** is displayed from the Phonebook.

**Ext no.** and **Ext name.** are alternately displayed every 2 seconds.



indicate alternately every 2 seconds



If the extension name or number is too long for the display area, the excess text or numbers will be truncated.

## Clock and Calender

This area consists of a calendar and clock. The default display format follows setting of the system.

It is possible to change the format by user settings. Refer to [To Set Time Format](#).

## Local Soft Key Display

The following local soft keys are displayed:

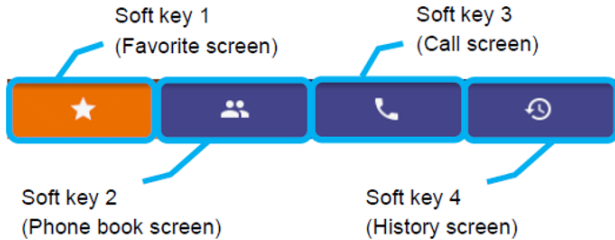

*In the local soft key display area, the screen which is being displayed is highlighted in orange. For example, soft key 1 is highlighted when the Favorite screen is displayed.*

- Local soft key 1 (Favorite screen)  
Go to the Favorite screen.
- Local soft key 2 (Phone book screen)  
Go to personal phone book or a system phone book.
- Local soft key 3 (Call screen)  
Go to the Call screen. Use this feature when you make a call or access to the system service etc.
- Local soft key 4 (History screen)  
Go to incoming and outgoing history screen.

## Call Screen

This screen is displayed by pressing local soft key 3 (Call screen).  
When pressing a digit key, a function key, or incoming call arrival, this screen is displayed. You can make a call, talk and use system services from this screen. For system service operation, refer to [FEATURE OPERATION](#).

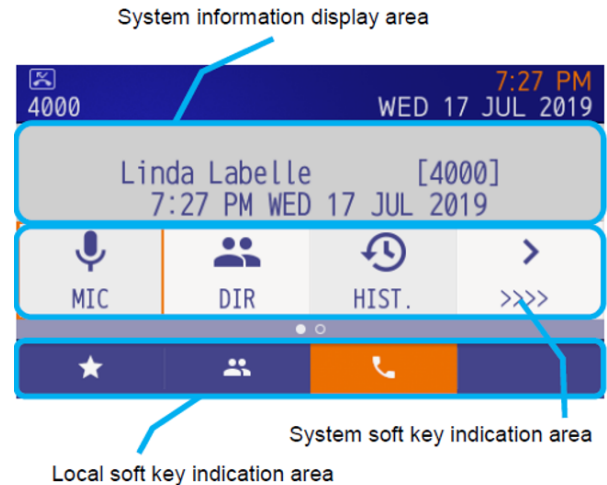

### System Information Area

Character information from the system is displayed.

### System Soft Key Area

The soft keys provided by the system are displayed in this area. It cannot be selected by pressing the local soft key.



#### How to select system soft key

*Move the orange colored focus using the cursor key and press the **Enter** key.*

## Local Soft Key Area

The soft keys provided by the terminal are displayed in this area. It is possible to go to the Favorite screen, Phone book screen and History screen (same operation as the Favorite screen).



*About Local soft key 2 (Phone book screen), if this feature is not available by initial settings, the icon is not displayed. For details, contact the administrator.*

## To Start Call Screen

Use the following procedure for displaying the Call screen.

When a screen other than the Call screen / Line screen is displayed and the Call screen is activated with a display method with a circle in the auto end column in the table below, the system is automatically set by on-hooking or abandoning the call. Exit the screen and return to the original screen. For details, see [To Close Call Screen Automatically](#).

Operations	Auto Close
When pressing local soft key that is assigned call screen icon.	
When there is an incoming call to the terminal (without assigning to the line key).	<input type="radio"/>
When you lift the handset.	<input type="radio"/>
When the terminal receives instructions from XML application server.	<input type="radio"/>
When a pop-up button on the XML application is pressed.	
When the terminal receives instructions from a system.	

## To Close Call Screen Automatically

If the system screen is displayed in a way that is subject to automatic termination, placing the handset on-hook or abandoning the call will return you to the screen before the call started.

However, automatic termination does not occur in the following cases.

Does Not Close Automatically
When a menu button is pressed and the XML application is selected by the application change screen during a call screen.
When the terminal receives instructions from an XML application server.
When a soft key other than soft key 3 is pressed, while the system screen is displayed to switch to another screen.

## Screen When the Phone Starts

The screen displayed at phone startup or when the Home key is pressed depends on settings. This section explains the settings related to the screen display.

### To Set the Home Screen

The following explains how to set a screen that will be displayed when the phone has started up or the Home key is pressed.

- (1) Display the **Menu** screen, select **Settings**.
- (2) Select **1 User Settings**.
- (3) Select **3 Display**.
- (4) Select **7 Portal Mode Settings**.
- (5) Select **4 Home Screen Setting**.



(6) Select a desired screen.



The default setting is  **Automatic**.  
If  **Automatic** is selected, this feature is activated using the system data setting.

## Register a Home URL

The screen display is not only set by the **Home screen settings**, but the phone can also be set to access the XML application right after start up by registering the address information of the application as a **Home URL**.

This section explains how to display the menu screen and an example of the screen display when the phone starts.



The XML application also can be used to register the Favorite screen as a shortcut of the service. For registering a shortcut or using a shortcut, refer to [To Register a Shortcut](#) or [To Use the Shortcut](#).  
In addition, shortcuts of the service can be used when address information has been registered as the service. For details, contact your administrator.



Registering the home URL is performed during the initial setting stage. For details, contact your administrator.

## To Start Up the Phone

The phone automatically accesses the Home URL and displays the received XML application.



The following XML application image is an example and depends on the application used.



Press the **Menu** button to display the menu screen. The screen that is displayed as the portal icon at that time is the XML application screen registered as the Home URL.



“Portal” is usually displayed as an application name registered by the external application.



When the home URL has been registered, the home URL screen is displayed instead of the favorite screen when local soft key 1 is pressed. The favorite screen cannot be displayed.  
When the Home URL is registered the following occurs in Home settings:

### **Automatic settings**

The screen obtained from the Home URL is displayed.

### **Favorite Screen settings**

The screen obtained from the Home URL is displayed.

### **Call Screen settings**

The call screen is displayed.

This page is for your notes.

# 5. TERMINAL SETUP – PORTAL

## Terminal Setup



While you set up the terminal, the “soft key” means local soft key.

## Adjusting Volume



Adjusting volume is available on the call screen only.

- If the Back/Exit button is pressed while the Terminal Setting menu is displayed, the Favorite screen is displayed regardless of Home screen settings.

Display example for adjusting volume levels.

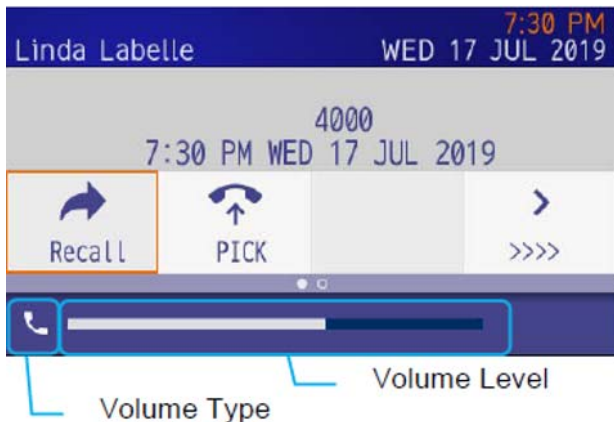

## To Adjust Handset Receiver Volume

The volume level of the handset receiver can be adjusted during a call in progress using handset.

Press the Up /Down key in the Offhook status or during a call when using the handset.

## To Adjust Speaker Volume

The volume level of the speaker can be adjusted during a call in progress using speaker.

Press the Up /Down key during speakerphone operation or during a call using the speaker.



## To Adjust Ringer Tone

The volume level of the ringer tone can be adjusted during an incoming call arrival.

Press the Up /Down key during ringing.

## Setup With Feature Key

### Microphone On/Off

- (1) LED on  shows the status of the built-in microphone.
- (2) Press the MIC key or press  and **1**.



## Setup with Menu Key

### Enable/Disable Off-Hook Ringing

The procedure below shows how to enable/disable Off-hook ringing.



- (1) Display the **Menu** screen, select **Settings**.
- (2) Select **1** **User Settings**.

Select an item by one of the following operations.

- Highlight an item by using , and press ,  or **OK**.
- Press **1**.



- (3) Select **1** **Incoming Call**.

Select an item by one of the following operations.

- Highlight an item by using , and press ,  or **OK**.
- Press **1**.



- (4) Select **1** **Offhook Ring**.

Select an item by one of the following operations.

- Highlight an item by using , and press ,  or **OK**.
- Press **1**.

- (5) To disable/enable the off-hook ringing, choose **1** **Disable** or **2** **Enable**.

Select an item by one of the following operations.

- Highlight an item by using , and press  or **OK**.
- Press **1** or **2**, and press  or **OK**.

**TIP** Default setting is **Enabled**.

**TIP** The enabled item is highlighted.

### To Set Ringing of Headset

The procedure below shows how to enable/disable the ringing of headset.



*This feature is required for both terminals and system settings during initial installation. For details, contact the system administrator.*

- (1) Display the **Menu** screen, select **Settings**.
- (2) Select **1** **User Settings**.
- (3) Select **1** **Incoming Call**.
- (4) Select **2** **Headset Ring**.
- (5) To disable/enable the ringing of headset, choose **1** **Disable** or **2** **Enable**.



*Tone Type 1 – Tone Type 8:  
In the preview function, each ringer tone sounds continuously. However, when “**0** Automatic” is selected, each ringer pattern of internal and external incoming calls is set by the initial system settings. For details, contact the system administrator.*



*When selecting “**0** Automatic”, the preview function is not supported. Use the Feature key to enable this function.*



Music Ring 1, 2 and 3 have been installed at the factory with firmware 2.1.0.0 or later. When using a ring tone music source other than Music Ring 1, 2 or 3, you must download the music file.





For the procedure to download a ringer tone file, refer to "To Download a File".

## Set Ringer Tone



The procedure below shows how to change the ringer tone for internal call and external call.

- (1) Display the **Menu** screen, select **Settings**.
- (2) Select **1 User Settings**.  
Select an item by one of the following operations.

- Highlight an item by using , and press , or **OK**.
- Press **1**.



- (3) Select **1 Incoming Call**.

Select an item by one of the following operations.

- Highlight an item by using , and press , or **OK**.
- Press **1**.



- (4) Select **3 Ring Tone**.

Select an item by one of the following operations.

- Highlight an item by using , and press , or **OK**.
- Press **3**.



- (5) Select **1 External Call** when setting the ringer tone for external calls. Select **2 Internal Call** when setting the ringer tone for internal calls.

Select an item by one of the following operations.

- Highlight an item by using , and press , or **OK**.
- Press **1** or **2**.

- (6) Select a desired tone type. You can preview designated ringer tone.

Select an item by one of the following operations.

- Highlight an item by using , and press  or **OK**.
- Press the digit key of desired number, and press  or **OK**.  
For example, press **1** + **5** to select **15 Download 1**.

No.	Menu Item	Frequency (Hz)		Remarks
		1st	2nd	
0	Automatic	520	660	16Hz modulation
1	Tone Type 1	520	660	16Hz modulation
2	Tone Type 2	520	660	8Hz modulation
3	Tone Type 3	1400	1100	Door Phone
4	Tone Type 4	1100		No modulation
5	Tone Type 5	540		No modulation
6	Tone Type 6	1100	1400	16Hz modulation
7	Tone Type 7	660	760	16Hz modulation
8	Tone Type 8	1100		Envelope
9	Tone Type 9	-		Door Phone Melody
10	Tone Type 10	-		Melody 1
11	Tone Type 11	-		Melody 2
12	Tone Type 12	-		Melody 3

No.	Menu Item	Frequency (Hz)		Remarks
		1st	2nd	
13	Tone Type 13	–		Melody 4
14	Tone Type 14	–		Melody 5
15	Download 1	–		C Major Ring Tone (See note below.)
16	Download 2	–		Canon (See note below.)
17	Download 3	–		Turkish March (See note below.)

**Note:** There are three pre-installed melodies on the DT900 telephones. They include: Download 1: C major ringtone, Download 2: Canon and Download 3: Turkish March.

These pre-installed melodies are overwritten when you download a new ringtone.

**Note:** When selecting **Automatic** or not performing this ringer tone setting, **Tone Type 1** is automatically applied.

**Note:** When selecting **Automatic**, the preview function will not operate. Also, when selecting **Download 1/2/3**, the ringer tone file must be downloaded in advance. If there is no downloaded file, you hear no tone.

**Note: Tone Type 1 to Tone Type 8:**

In the preview function, each ringer tone sounds continuously. Actual ringer pattern of each tone is determined by the initial system settings.

**Note:** Terminal settings may not become effective, according to the system settings. For details, contact the System Administrator.

**TIP** The enabled item is highlighted.

**TIP** You can set the ringer tone for the telephone here. Ringer Tone type can be set for **Name**, **Group** and **Telephone set**. The ringer Tone type set for **Name** has higher priority than the types set for **Group** and **Terminal set**.

## To Set Illumination Pattern for Call Indicator Lamp

The procedure below shows how to set the illumination pattern (color of Call Indicator Lamp).

- (1) Display the **Menu** screen, select **Settings**.
- (2) Select **1 User Settings**.
- (3) Select **1 Incoming Call**.
- (4) Select **4 Illumination**.
- (5) Select **1 External Call** or **2 Internal Call**.
- (6) Select a desired illumination pattern.

## To Enable/Disable RTP Alarm

The procedure below shows how to enable/disable RTP alarm. The RTP Alarm allows the terminal user to be notified that the voice packet was not received in a certain period of time because of network delay etc.

- (1) Display the **Menu** screen, select **Settings**.
- (2) Select **1 User Settings**.
- (3) Select **2 Talk**.
- (4) Select **1 RTP Alarm**.
- (5) Select **0 Automatic**, **1 Disable** or **2 Enable** (see the following table).

Menu Items	Description
0 Automatic	Follow the system settings. If no setting is made in the system, the default setting (Alarm=ON) is applied.
1 Disable	Follow the terminal settings (OFF).
2 Enable	Follow the terminal settings (ON).



If the **0** Automatic is selected, this feature is activated using the system data settings. If not specified by system data, the feature (RTP Alarm = ON) is used. Contact the system administrator for details.

### To Enable/Disable DTMF Tone

The following shows how to set whether the DTMF Tone is played when the other party's telephone has a button pressed during a call.

- (1) Display the **Menu** screen, select **Settings**.
- (2) Select **1 User Settings**.
- (3) Select **2 Talk**.
- (4) Select **2 DTMF Tone**.
- (5) Select **0 Automatic**, **1 Disable** or **2 Enable** (see the following table).

Menu Items	Description
0 Automatic	Follow the system settings. If no setting is made in the system, the default setting (DTMF=ON) is applied.
1 Disable	Follow the terminal settings (OFF).
2 Enable	Follow the terminal settings (ON).



If the **0** Automatic is selected, this feature is activated using the system data settings. If not specified by system data, the feature (DTMF TONE = ON) is used. Contact the system administrator for details.

### To Set Key Touch Tone

The following explains how to set the Key Touch Tone. Key Touch Tone is a tone generated when the digit keys are pressed while the terminal is off-hook.

- (1) Display the **Menu** screen, select **Settings**.
- (2) Select **1 User Settings**.
- (3) Select **2 Talk**.
- (4) Select **3 Key Touch Tone**.
- (5) Select the desired mode of Key Touch Tone.



If the **0** Automatic is selected, this feature is activated using the system data settings. Contact the system administrator for details.

### To Set Music on Hold

The procedure below shows how to set Music on Hold to be heard by the terminal user.

- (1) Display the **Menu** screen, select **Settings**.
- (2) Select **1 User Settings**.
- (3) Select **2 Talk**.
- (4) Select **4 Hold Music**.
- (5) Select a desired Music on Hold.

Choose **1 Default** when the default data (Minuet) is used as Music on Hold. Choose **2 Download** when a downloaded data is used as Music on Hold.



When selecting "Download", the Music on Hold file must be downloaded in advance. If there is no downloaded file, you hear no tone in the preview function (in actual operating conditions, "Minuet" is automatically applied).



For the procedure to download a ringer tone file, refer to “To Download a File”.

## To Set Time Format

Determines whether the time is displayed using a 12-hour or 24-hour clock format.

**Note:** This setting is available for Time Display only. Call Log feature displays the time in 24-hour format regardless of this setting.

- (1) Display the **Menu** screen, select **Settings**.
- (2) Select **1 User Settings**.
- (3) Select **3 Display**.
- (4) Select **1 Calendar Format**.
- (5) Select **2 Time Format**.
- (6) Make a selection from the following list.

Menu Items	Description
0 Automatic	Follow the system settings.
1 12-hour indication	12-hour clock
2 24-hour indication	24-hour clock



If the **0** Automatic is selected, this feature is activated using the system data settings. Contact the system administrator for details.

## To Enable/Disable Volume Level Display

Determines whether or not to display the following volume levels: handset receiver volume, speaker volume, ringer tone volume and LCD contrast.

- (1) Display the **Menu** screen, select **Settings**.

- (2) Select **1 User Settings**.
- (3) Select **3 Display**.
- (4) Select **2 Local Volume**.
- (5) Make a selection from the following list.

Menu Items	Description
0 Automatic	Each volume level is displayed on LCD.
1 Disable	Each volume level is not displayed on LCD.
2 Enable	Each volume level is displayed on LCD.



If set to **0** Automatic, the default setting **2 Enable** is applied.

## To Set Screen Saver

Screen Saver works after the telephone is idle for a certain period of time. The Screen Saver will be displayed from XML server when the XML server is available. If the Screen Saver cannot be downloaded from the XML server, the default Screen Saver will be displayed.

**Note:** For details on the XML service, contact the System Administrator.

- (1) Display the **Menu** screen, select **Settings**.
- (2) Select **1 User Settings**.
- (3) Select **3 Display**.
- (4) Select **3 Screen Saver**.
- (5) Choose **1 Screen Saver Mode**.
- (6) Choose either **1 Disable** or **2 Enable**.
- (7) Select **2 Wait Time**.



- (8) Input **Wait Time** (1-999 min) and press **OK**.



*This terminal has a screen saver enabled by default. If you disable the screen saver and the same screen is displayed for an extended period of time, an afterimage may appear on the display. This is not a malfunction. The afterimage is gradually eliminated by changing the screen display. However, if the same screen is displayed for too long, the afterimage will not disappear, so keep the screen saver enabled.*

### To Set Brightness of LCD Backlight

The following steps show how to set the brightness level of the LCD backlight.

- (1) Display the **Menu** screen, select **Settings**.
- (2) Select **1** **User Settings**.
- (3) Select **3** **Display**.
- (4) Select **4** **Back Light**.
- (5) Select a desired brightness level.



*The lighting time of back light is set by system data setting at initial installation (initial setting is 10 seconds). Contact the system administrator for details.*



### Set a Language

The following explains how to set a language to be displayed on LCD.

- (1) Display the **Menu** screen, select **Settings**.
- (2) Select **1** **User Settings**.
- (3) Select **3** **Display**.
- (4) Select **5** **Language**.

- (5) Select a desired language.

Select an item by one of the following operations.

- Highlight an item by using , and press  or **OK**.
- Press the digit key of desired number, and press  or **OK**.  
For example, press **1** + **5** to select **15** **Spanish**.

**TIP** Default setting is **Automatic**.

**TIP** When selecting **Automatic**, follow the setting on the System. For the setting on the System, contact to the System Administrator.

**TIP** The enabled item is highlighted.

### To Set Turn Off Display

The Turn off Display works after the telephone is idle for a certain period of time. The following shows how to set Turn off Display.

- (1) Display the **Menu** screen, select **Settings**.
- (2) Select **1** **User Settings**.
- (3) Select **3** **Display**.
- (4) Select **6** **Advanced**.



*When GUI mode is classic, enter number **7**.*

- (5) Select **1** **Turn Off Display**.



*When GUI mode is classic, enter number **4**.*

- (6) Choose **1** **Turn Off Display Mode**.

(7) Select whether to launch Turn Off Display.



When **3** App priority is selected, the Screen Saver is set to an external application. When the external application orders the LCD to turn off while the Screen Saver activates, the display will be turned off.



The Screen Saver can be set to use an external application. For details, contact the system administrator.

(8) Select **2** Wait Time.

(9) Input the **Wait Time** (1-999 min) and press **OK**.



When **3** App priority is selected for **Turn Off Display**, if the external application does not give instructions to turn off the display, the **Wait Time** setting will be invalid.

### To Enable/Disable LCD Backlight Fade Control

The following explains how to set Backlight Fade Control. When you set Backlight Fade Control as **Enable**, you can turn on/off the LCD smoothly.

(1) Display the **Menu** screen, select **Settings**.

(2) Select **1** User Setting.

(3) Select **3** Display.

(4) Select **6** Advanced.



When GUI mode is classic, enter number **7**.

(5) Select **2** Backlight Fade Control.



When GUI mode is classic, enter number **5**.

(6) Choose either **1** Disable or **2** Enable.

### To Change GUI Mode

The following explains how to change the GUI mode.

(1) Display the **Menu** screen, select **Setting**.

(2) Select **1** User Setting.

(3) Select **3** Display.

(4) Select **6** Advanced.



When GUI mode is classic, enter number **7**.

(5) Select **3** GUI Mode.



Menu number depends on terminal type.

Example of GUI when in Classic Mode.





If selected, **0** Automatic follows system settings. For details, contact the system administrator.

## Portal Mode

The following explains how to set the Portal Mode.

- (1) Display the **Menu** screen, select **Settings**.
- (2) Select **1** **User Settings**.
- (3) Select **3** **Display**.
- (4) Select **7** **Portal Mode**.
- (5) Select **1** **Delete Shortcut**.

This will take the user to the main screen to select a shortcut to be sent to the trash can.

## To Change Theme

- (1) Display the **Menu** screen, select **Settings**.
- (2) Select **1** **User Settings**.
- (3) Select **3** **Display**.
- (4) Select **7** **Portal Mode Settings**.
- (5) Select **2** **Change Theme**

Select either White Theme or Black Theme to change the background in Portal Mode. White is default.

Example of display when theme is Black.

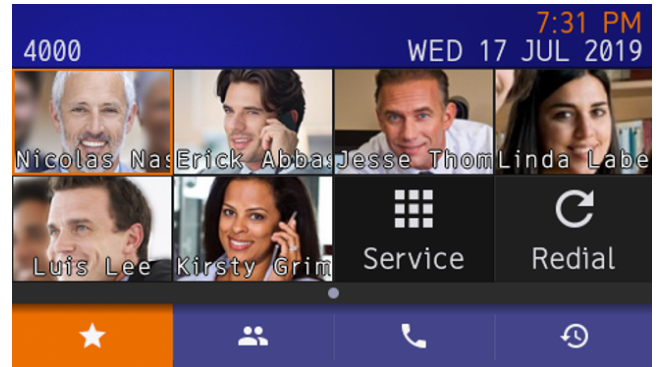

## To Change Password

To change an existing password, follow the procedure below. This password is used for the following occasions.

- To lock/unlock the telephone.
  - To reset the telephone settings.
- (1) Display the **Menu** screen, select **Settings**.
  - (2) Select **1** **User Settings**.
  - (3) Select **4** **Change Password**.
  - (4) Enter the old password.



The initial password is "0000". When changing the password for the first time, enter "0000" as the old password. In order to ensure the security and avoid the unauthorized use, be sure to change the password at the time of initial use. The password should be difficult for a third party to guess. Also, it should be changed regularly to keep security level.

(5) Enter the new password.



*A maximum of 32 digits can be set as a password.*

(6) Enter the new password again.

(7) Press **Soft key (OK)**

The password entry completes successfully.

- When the password entry ends in failure, the error message is displayed.



*When a password has been forgotten, contact the system administrator.*

### To Set Usability

The procedure below shows how to set the operation of Help key while pop-up window is displayed.



*This function is available when the GUI mode is set to Classic.*

- (1) Display the **Menu** screen, select **Settings**.
- (2) Select **1 User Settings**.
- (3) Select **6 Usability**.
- (4) Ensure **1 Help Key Mode** is specified.
- (5) Choose the desired **Help** key mode.

**Note:** Select an item by one of the following operations.

- Press **1** or **2**, and press **OK**.

No.	Item	Description
1	Option Menu	Set the <b>Home</b> key which displays option menu.
2	Pop-up Window	Set the <b>Home</b> key that displays pop-up window.

### Reset Telephone Settings

The following explains how to clear personal data off the telephone.

- (1) Display the **Menu** screen, select **Settings**.
- (2) Select **1 User Settings**.
- (3) Select **0 Setting Reset**.
- (4) Enter the password.

After entering the password, press  or **OK**.

- (5) When the password entry completes successfully, the display changes as follows.

Press  or **OK** to clear the personal data off the telephone.

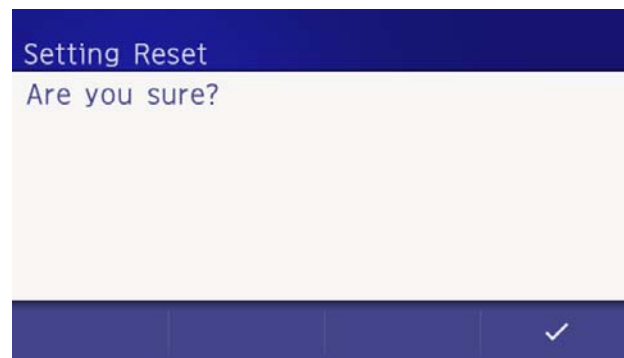

**TIP**

When the password entry ends in failure, the following error message is issued. In that case, press **OK** and make a retry.

### Setting Reset

Are you sure?



## To Download a File

You can download files for Music on Hold, Ringer Tone, and Wallpaper.

When downloading these files, the DT930 needs to be connected to the network that has FTP/TFTP/HTTPS server.

**Note:** For details on the FTP/TFTP/HTTPS service, contact the System Administrator.

Before starting the download, the IP Address of the FTP/TFTP/HTTPS Server must be entered from DT930.

- (1) Set up the FTP/TFTP/HTTPS server.

<FTP server>

Put the downloading file into the designated directory (for Windows IIS, the default is "C:\inetpub\ftproot") of the FTP server.

<TFTP server>

Put the downloading file into a desired directory of TFTP server and specify it as the directory for downloading.



<HTTPS server>

Put the downloading file into a desired directory of the HTTPS server and specify the directory for downloading.

**Note:** Refer to the DT Resource Manual for HTTPS server.



- (2) Display the **Menu** screen, select **Settings**.
- (3) Select **2 Download**.

Select an item by one of the following operations.

- Highlight an item by using , and press , or **OK**.
- Press **2**.



- (4) Select **3 Protocol**.

Select an item by one of the following operations.

- Highlight an item by using , and press , or **OK**.
- Press **3**.

- (5) Choose a protocol used by the server which stores the download file.

Select an item by one of the following operations.



- Highlight an item by using , and press  or **OK**.
- Press **1**, **2** or **3**, and press  or **OK**.

- (6) The display returns to the **Download Menu** screen.

If **1** **FTP** is selected here, continue with [STEP 7](#).  
If **2** **TFTP** is selected here, proceed to [STEP 15](#).  
If **3** **HTTPS** is selected here, proceed to [STEP 7](#).



(7) Select **4** **Account Settings**.

Select an item by one of the following operations.

- Highlight an item by using , and press , or **OK**.
- Press **4**.

(8) Select **1** **User ID**.

Select an item by one of the following operations.

- Highlight an item by using , and press , or **OK**.
- Press **1**.



(9) Enter a **User ID**.

Enter a User ID by pressing digit keys, and press  or **OK**.

**TIP** For details on character entry method, see [How to Input Characters](#).

(10) The display returns to the **Account Settings** screen. Select **2** **Password**.

Select an item by one of the following operations.

- Highlight an item by using , and press , or **OK**.
- Press **2**.



(11) Enter a password.

Enter a User ID by pressing digit keys, and press  or **OK**.

**TIP** For details on character entry method, see [How to Input Characters](#).

(12) The display returns to the **Account Settings** screen. Select **3** **Folder**.

Select an item by one of the following operations.

- Highlight an item by using , and press , or **OK**.
- Press **3**.

(13) Enter the directory where the download file is stored.



After entering the directory, press  or **OK**.

**TIP** For details on character entry method, see [How to Input Characters](#).

(14) The display returns to the **Account Settings** screen. Press  or **Back** to display the **Download Menu** screen.

(15) Select **2** **Download Address**.

Select an item by one of the following operations.



- Highlight an item by using , and press , or **OK**.
- Press **2**.

(16) Enter an **IP address** of the FTP/TFTP/HTTPS server which stores the download file.

For example, to set the IP address of 10.41.208.205, enter 10\*41\*208\*205 [separate with an asterisk (\*)].

(17) The display returns to the **Download Menu** screen. Select **1** **Download Files**.

Select an item by one of the following operations.



- Highlight an item by using , and press ,  or **OK**.
- Press **1**.

(18) Select file to be downloaded.

When downloading a file for Music on Hold	Select <b>1</b> <b>Hold Music</b> and go to <b>STEP 20</b> .
When downloading a file for ringer tone	Select <b>2</b> <b>Ring Tone</b> and go to <b>STEP 19</b> .
When downloading a file for Wallpaper	Select <b>4</b> <b>Directory</b> and go to <b>STEP 20</b> .

(19) When **2** **Ring Tone** is selected at **STEP 18**, the following **Ring Tone** screen is displayed. Select either **1** **Music Ring 1**, **2** **Music Ring 2** or **3** **Music Ring 3**.

Select an item by one of the following operations.

- Highlight an item by using , and press ,  or **OK**.
- Press **1** - **3**.

(20) The default file name will be displayed.

When downloading a file for Music on Hold, the default file name is **MOH.wav**.

File Format	Maximum Size
PCM $\mu$ -law 8kHz/s wav.	under 32 seconds

When downloading a file for ringer tone, the default file name is **Melody1/2/3/.wav**.

File Format	Maximum Size
PCM $\mu$ -law 8kHz/s wav.	under 32 seconds

When downloading a file for Wallpaper, the default file name is **WallPaper.bmp**.

File Format	Maximum Size
bmp/jpg/gif/png	480 X 272 Pixels

If changing the file name, continue with **STEP 21**.

If not changing the file name, proceed to **STEP 22**.

(21) Press **BK** once to delete the default file name and enter a new file name by using the digit keys.

*Note:* A maximum of 64 characters (“0-9”, “A-Z”, “a-z”, “\*”, “#”, “.”, “-” or “\_”) can be entered as a file name.

**TIP** For details on character entry method, see [How to Input Characters](#).

**TIP** To delete an entered character, press **BK**.

(22) Press  or **Exec** to start the downloading process.

While downloading a file, the LCD displays “Downloading...” first and “Saving...”.

*Note:* While “Saving...” is displayed on the LCD, do not to power OFF the DT930.

- (23) When the downloading process completes, the following is displayed.



- (24) The display returns to the **Download Files** screen upon **Exit**.

*Note:* When the downloading process ends in failure, **Downloading Failed!** is displayed on the LCD. Check the following and retry.

Check Points	Actions
Download file is not placed in the specified directory.	Place the download file in the specified directory.
A different file name is specified between DT930 and FTP/TFTP/HTTPS server.	Set the same file name from both DT930 and FTP/TFTP/HTTPS server.
Incorrect IP address of FTP/TFTP/HTTPS server has been entered from the telephone.	Set the proper IP address of FTP/TFTP/HTTPS server.
The power to FTP/TFTP/HTTPS server or network equipment is Off.	Turn On the power.
LAN cable is disconnected.	Reconnect the cable securely.

## Backup or Restore the Settings Data of the Terminal

This section explains how to make a backup of the settings data which has been entered in the terminal to FTP/TFTP/HTTPS server. The data in the FTP/TFTP/HTTPS server can also be restored to the terminal.



When downloading these files, the terminal needs to be connected to the network that has FTP, TFTP or HTTPS server. For details about the FTP/TFTP/HTTPS service, contact the system administrator.

### To Backup the Settings Data of the Terminal

- (1) Display the **Menu** screen, select **Settings**.
- (2) Select **3 Data Backup/Restore**.
- (3) Select **4 Protocol**.
- (4) Choose a protocol type of the server which will store the Backup file.
- (5) According to the selection in [Protocol] screen, proceed with the following steps below.
- (6) Display the **Menu** screen, select **Settings**.
  - If **1 FTP** is selected, continue to with **STEP 7**.
  - If **2 TFTP** is selected, proceed to **STEP 13**.
  - If **3 HTTPS** is selected, proceed to **STEP 7**.
- (7) Select **5 Account Settings**.
- (8) Select **1 User ID**.



(9) Enter a **Used ID** using digit keys.



For details on character entry method, see [How to Input Characters](#).

(10) Select **2 Password**.

(11) Enter a password by using digit keys and press **OK**.

(12) Select **3 Folder**.

(13) Enter the folder name where the download file is stored.



For details on character entry method, see [How to Input Characters](#).

- Enter the name of the folder where the files are stored in the server (including path from root directory to the folder that stored the backup).

(14) Press the **Left** key or Soft key (**Back**).

(15) Select **3 Server Address**.

(16) Using digit keys, enter an **IP Address** of the FTP/TFTP/HTTPS server.

Use Asterisk key for separator of IP Address.

To enter the address of (URI) of FTP/TFTP/HTTPS, press Soft key (IP/URI) to switch the display to the URI input screen.

- Press Soft key (IP/URI)
- Using the Dial keys, enter the address (URI) of the server where the files are stored.



For details on character entry method, see [How to Input Characters](#).



The IP Address input screen can be switched to URI input screen by the Soft key (IP/URI)

- Press Soft key (IP/URI).
- Press Soft key (IP/URI) again to go back to the IP address input screen.

(17) Select **1 Data Backup**.

(18) Enter the **file name** using digital keys.

The default name is displayed.

- Press Soft key (BK) once to delete the default file name.
- Enter the Backup file name to be used.



For details on character entry method, see [How to Input Characters](#).



A maximum of 64 characters can be entered as a file name.



When you send to a terminal the data from the server, it is possible to select the file format with encryption.

- Press Soft key (Enc) to send the file with encryption.
- Press Soft key (No Enc) to send the file without encryption.



Do not change the extension of the backup file. The setting data of the terminal can only be backed up as a (.tgz)/(.tgz.ef) file.

(19) Press Soft key (**Exec**).

The backup is started.

(20) Press Soft key (**Exec**).

The display returns to the (Backup/Restore screen).



When the backup process fails, "Upload Failed", is displayed on the LCD. Check the following points and retry backup.

Check Points	Actions
Check if the IP address/ Address (URI) of FTP/ TFTP/HTTPS server is correct or not.	Set the proper IP address/ address (URI) of FTP/TFTP/ HTTPS server.
Verify the power to FTP/ TFTP/HTTPS server and network equipment is ON or OFF.	Turn the power ON.
Verify the LAN cable is securely connected.	Reconnect the cable if required.



If the upload continues to fail, it may be a failure in the terminal. Contact the system administrator for details.



For conditions other than those described above, if "Download Failed" or "Upload Failed" is displayed, contact the system administrator.

(21) After the data backup completes, the display changes to the following:



### To Restore the Settings Data of the Terminal

- (1) Display the **Menu** screen, select **Settings**.
- (2) Select **3 Data Backup/Restore**.
- (3) Select **4 Protocol**.
- (4) Choose a protocol used by the server which stores the backup file.
- (5) According to the selection in [Protocol] screen, proceed with the following steps below.
  - If **1 FTP** is selected, continue with **STEP 6**.
  - If **2 TFTP** is selected, proceed to **STEP 12**.
  - If **3 HTTPS** is selected, proceed to **STEP 6**.
- (6) Select **5 Account Settings**.
- (7) Select **1 User ID**.

(8) Enter a **User ID** with digit keys.



*For details on character entry method, see [How to Input Characters](#).*

(9) Select **2 Password**.

(10) Enter a **Password** with digit keys and press **OK**.



*For details on character entry method, see [How to Input Characters](#).*

(11) Select **3 Folder**.

(12) Enter the folder name where the backup file is stored.

Enter the directory and press **OK**.



*For details on character entry method, see [How to Input Characters](#).*

(13) Press the **Left key** or **Soft key (Back)**.

(14) Select **3 Server Address**.

(15) Enter the **IP Address of the FTP/TFTP/HTTPS** server with digit keys.

Use Asterisk key for separator of IP Address.

To enter the address of (URI) of FTP/TFTP/HTTPS, press Soft key (IP/URI) to switch the display to the URI input screen.

- Press Soft key (IP/URI)
- Using the Dial keys, enter the address (URI) of the server where the files are stored.



*For details on character entry method, see [How to Input Characters](#).*



*The IP Address input screen can be switched to URI input screen by the Soft key (IP/URI)*

- *Press Soft key (IP/URI).*
- *Press Soft key (IP/URI) again to go back to the IP address input screen.*

(16) Select **2 Data Restore**.

(17) Enter the file name using digital keys.

The default name is displayed.

- Press Soft key (BK) once to delete the default file name.
- Enter the file name previously backed up in the [To Backup the Settings Data of the Terminal](#) section.



*For details on character entry method, see [How to Input Characters](#).*



*A maximum of 64 characters can be entered as a file name.*



*When you send to a terminal the data from the server, it is possible to select the file format with encryption.*

- *Press Soft key (Enc) to send the file with encryption.*
- *Press Soft key (No Enc) to send the file without encryption.*



*Do not change the extension of the backup file. The setting data of the terminal can only be backed up as a (.tgz)/(.tgz.ef) file.*

(18) Press Soft key (**Exec**).

The download is started.

(19) Press Soft key (**Exec**).

The display returns to the (Backup/Restore screen).



*When the backup process fails, "Download Failed", is displayed on the LCD. Check the following points and retry backup.*

Check Points	Actions
Check if the download file is placed in the folder of the server or not.	Place the download file in the specified folder of the server.
Check if the file name matches file stored in FTP/TFTP/HPPS server.	Enter the correct file name which is stored in FTP/TFTP/HTTPS server.
Is the downloaded file a terminal data file of the same model?	Terminal data of the different model can't be downloaded. Download terminal data of the same model.
Check if the IP address/Address (URI) of FTP/TFTP/HTTPS server is correct or not.	Set the proper IP address/address (URI) of FTP/TFTP/HTTPS server.
Verify the power to FTP/TFTP/HTTPS server and network equipment is ON or OFF.	Turn the power ON.
Verify the LAN cable is securely connected.	Reconnect the cable if required.



*If the download continues to fail, it may be a failure in the terminal. Contact the system administrator for details.*



*For conditions other than those described above, if "Download Failed" or "Upload Failed" is displayed, contact the system administrator.*

(20) After the download process completes, the display changes to the following:



# 6. FEATURE OPERATION

This chapter describes how to login/logout, how to input characters and how to make a call/hold, etc.

## Login/Logout

### To Login

When login mode is activated, the terminal prompts for Login ID and Password. When the terminal starts up with displaying the below screen, the Login Mode is activated.



(1) The terminal starts up with the login mode.

(2) Enter **Login ID**.



*For initial setting, enter the extension number as Login ID.*



*A maximum of 16 characters can be entered for Login ID.*

○ After entering Login ID, press Soft key **Set**.

(3) Enter a **password**.



*For initial setting, enter the extension number as password.*



*Four to 10 characters can be entered for password displayed in “\*”.*

○ After entering password, press Soft key **OK**.

(4) If the Login ID and Password are accepted, display changes to normal idle status.

The terminal becomes available.



■ *If you enter the wrong ID and/or password, the normal screen is not displayed and will return to the [Login] screen.*

■ *If this occurs, enter the correct “Login ID” and “Password”.*

### To Logout

The terminal, which is operated with Login Mode, can log out. Perform the following to logout.

(1) Press system softkey ↓ .

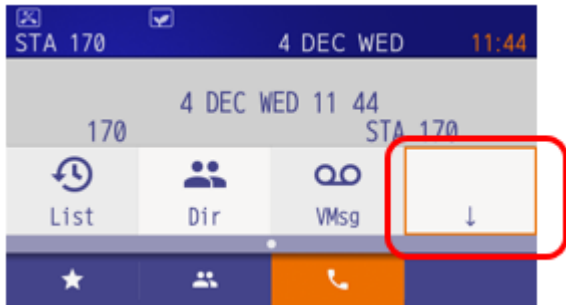

(2) Press system softkey **Prog**.

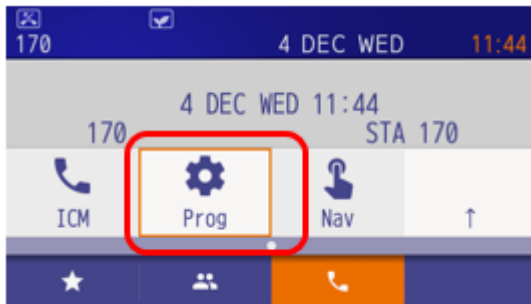

(3) Press system softkey ↓ three times.

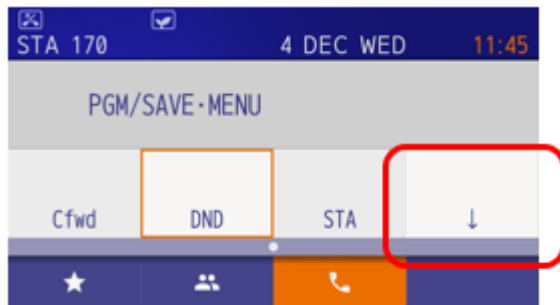

(4) Press system softkey **LOGOFF**.

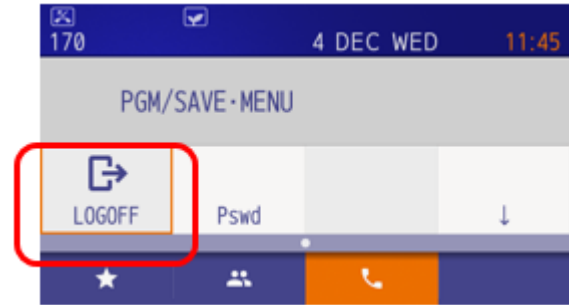

(5) Press system softkey **Yes**.

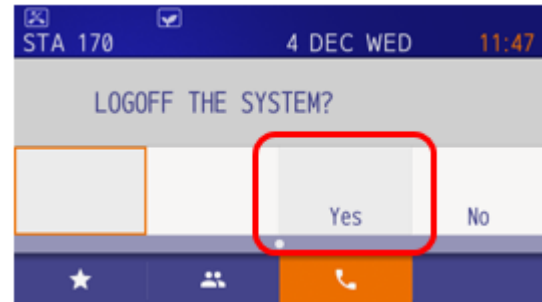

The terminal goes off.

## Making a Call

This section explains Preset Dialing. Before making a call, the terminal user can verify the dialed number displayed on the LCD. When a wrong number is entered, the user can correct the number before originating the call.

### To Make an External Call

The following explains how to make an external call.

- (1) Dial the Central Office access code, then the desired number.
- (2) Press the **Speaker** key.
  - Place the call.
  - Speaker key lamp lights Red.

### To Make an Internal Call

The following explains how to make an internal call.

- (1) Dial the desired number.
- (2) Press the **Speaker** key.
  - Place the call.
  - Speaker key lamp lights Red.

## Answering a Call

The following explains how to answer a call with the Answer key.

### To Answer an External Call

- (1) You hear the ringing tone.
  - The Call Indicator Lamp flashes red.
  - The Line key lamp lights red.
- (2) Press **Answer** key.

The Call Indicator Lamp goes off.  
The Speaker key lamp lights red.  
The Line key lamp lights green.

- (3) Lift the handset to answer the call.



*A call can also be answered by pressing the Line key that is flashing instead of the Answer key.*



*Or, a call can be answered by lifting the handset and pressing the Answer key or Line key.*

### To Answer an Internal Call

The following procedure explains how to answer an external call.

- (1) You hear the ringing tone.
  - The Call Indicator Lamp flashes red.
  - The Line key lamp lights red.
- (2) Press **Answer** key.
  - The Call Indicator Lamp goes off.
  - The Speaker key lamp lights red.
  - The Line key lamp lights green.
- (3) Lift the handset to answer the call.

## Holding a Call (Using Call Hold)

This feature allows a terminal user to hold a call in progress by pressing the Call Hold key. This line can then be used for originating another call or returning to a previously held call.

## To Hold

- (1) With a call in progress:  
The Line key that is used during a call lights green.  
The Line key on the other terminals lights red.
- (2) Press the **Hold** key.  
The person on the other end hears the Music on Hold.  
The Line key that is placed on hold flashes green  
The Line key on the other terminals flash red.
- (3) Replace the handset or make a new call.

## To Retrieve the Held Call

The following explains how to retrieve the held call.

- (1) While holding a call:  
Line key that is placed on hold flashes green
- (2) Press Line key that is placed on hold.  
The Line key lamp lights green.
- (3) Lift the handset and return to the held call.
- (4) A call on hold can be retrieved from another terminal that has the same Line key flashing red.

## If Unanswered



*After a predetermined time, Automatic Recall is initiated and the user hears the Automatic Recall ringer tone. Default time is one minute.*



*The starting time to ring the Automatic Recall is set using system data during initial installation. For details, contact the system administrator.*

## Holding a Call (Using Exclusive Call Hold)

This feature allows a terminal user to place a call on Hold and to exclude all other station users from retrieving the held call.

### To Hold

The following explains how to hold the call in progress.

- (1) With a call in progress:  
The Line key that is used during a call lights green.  
The Line key on the other terminals lights red.
- (2) Press the **Feature** key.
- (3) Press the **Hold** key.  
The Line key that is placed on hold flashes green  
The Line key on the other terminals lights red.  
Feature key lamp goes off.
- (4) Replace the handset.

### To Retrieve the Held Call

The following explains how to retrieve the held call.

- (1) While holding a call:  
Line key that is placed on hold flashes green.
- (2) Press Line key that is placed on hold.  
The Line key lamp that was placed on hold lights green.  
The Line key on the other terminals lights red.
- (3) Lift the handset and return to the held call.  
Only a terminal set for Exclusive Hold can retrieve the held call.



## If Unanswered



*After a predetermined time, Automatic Recall is initiated and the user hears the Automatic Recall ringer tone. Default time is one minute.*



*The starting time to ring the Automatic Recall is set using system data during initial installation. For details, contact the system administrator.*

## Transfer a Call

### To Transfer a Call (With Announcement)

This feature allows a terminal user to transfer incoming or outgoing calls to another terminal within the system.

#### Initiate Transfer (By Ex.200)

- (1) With a call in progress:  
The Line key lamp lights green.
- (2) Press the **Transfer** key.  
You will receive a special dial tone.  
The Calling party is placed on hold.
- (3) Dial the destination extension number.  
You will receive a dial tone.  
The dialed extension number is displayed with flash.
- (4) The destination answers the transferred call.
  - After the call is answered, announce the call is transferred.
- (5) Replace the handset.  
Line key lamp goes off.  
A call is transferred.

### Answer to a Transferred Call (By Ex.210)

- (1) A ringing is heard.  
The Call Indicator lamp flashes.  
The Line key lamp flashes red.  
The extension number that initiates call transfer is displayed on the LCD.
- (2) Lift the handset to start a conversation with the extension (200).  
The Call Indicator lamp goes off.  
The Line key lamp lights green.
- (3) Start conversation with transferred party.
  - Extension (200) replaces the handset.

### To Transfer a Call (Without Announcement)

After dialing the transfer destination number, the handset can be replaced before the destination party answers. When the transfer destination party lifts the handset, it is automatically connected with the transferred party. The phone number of the transferred party is displayed on the destination terminal.

#### Initiate Transfer (By Ex.200)

- (1) With a call in progress.  
The Line key lamp lights green.
- (2) Press the **Transfer** key.  
You will receive a special dial tone.  
Calling party is placed on hold.
- (3) Dial the destination extension number.  
You will receive a dial tone.  
The dialed extension number is displayed with flash.

- (4) Replace the handset.  
Line key lamp goes off  
The call is transferred.

### Answer A Transferred Call (By Ex.210)

- (1) A ringing is heard.  
The Call Indicator lamp flashes.  
The Line key lamp flashes red.  
The extension number that initiates call transfer is displayed on the LCD.
- (2) Lift the handset to start a conversation with the extension (200).  
The Call Indicator lamp goes off.  
The Line key lamp lights green.



*If the destination party does not answer within the predetermined time, a recall is made to the terminal that initiated the call transfer. When the recall is received, the destination number is displayed on the LCD.*

## One-Touch Speed Calling Keys

This feature allows a terminal user to dial frequently called numbers by pressing a One-touch key assigned for Station Speed Dialing.



*A maximum of 32 digits can be registered for each dial number.*



*The feature key is set by system data setting at initial installation. For details, contact the system administrator.*

### To Program

Following explains how to register a phone number to a One-touch Speed Calling key.

- (1) Press the **Feature** key.  
The Feature key lights red.
- (2) Press the **One-touch Speed Calling** key.  
The Feature key lamp flashes red.  
The Speaker key lamp lights red.
- (3) Dial the desired number.  
The Feature key lamp lights red.
- (4) Press the **Feature** key.  
The Feature key lamp goes off.  
The Speaker key lamp goes off.



*If you dial a wrong number, you will need to start again from the beginning.*



*To register a pause, press \* or # between any digits. (It is required system data setting at initial installation.) The pause can not be registered as a first digit.*



*If a phone number has been already registered in One-touch key, that number is displayed on the LCD. The previous number will be cleared when you register a new number.*

### To Verify

The following explains how to confirm the registered number in the One-touch Speed Calling key.

- (1) Press the **Feature** key.  
The Feature key lights red.

- (2) Press the desired **One-touch Speed Calling** key.

The Feature key lamp flashes red.  
The Speaker key lamp lights red.  
The registered number is displayed on the LCD.

- (3) Press the **Speaker** key.

The Feature key lamp goes off.  
The Speaker key lamp goes off.

### To Make a Call

The following explains how to make a call with One-touch Speed Calling key.

- (1) Press the **One-Touch Speed Calling** key.



The Speaker key lamp lights red.  
The desired number is automatically dialed.

- (2) When the party answers, lift the handset.

The Speaker key lamp goes off.

## Speed Dialing – Station/Group

### Set Speed Dial Bin

- (1) Press . Receive Dial Tone.  lamp lights red.

- (2) Dial the system or group storage code.



Set Sys

#### TIP

For the assignment of Speed Calling - Station/Group Access Code, contact the PBX maintenance personnel.

- (3) Dial the desired speed dial bin. In this example, “001” is dialed as the desired speed dial bin.



SYS 001



- (4) Dial the destination telephone number.



SYS 0001      2145551212

- (5) Press **Hold**.
- (6) Enter a name associated with the Speed Dial Number.
- (7) Press **Hold** again.
- (8) Press the  key to hang up.

### Make a Call

- (1) Press  (**Redial**).
- (2) Press the desired speed calling number.
- (3) Lift the handset.  lamp goes off.

## Last Number Redial

It is possible to search and redial up to 60 phone numbers previously dialed.

- (1) Press the **Left** key or Soft key (**OG**) then press Soft key (**HIST**).

The Speaker key lamp lights red.  
The Line key lamp lights green.

- Press Soft key (**↑Prev**) or Soft key (**↓Next**) to find the desired number and press the “#” key.

The number on the LCD is automatically redialed.

- When the party answers, lift the handset.

The Speaker key lamp goes off.

## Redial

The last number that was dialed is displayed.

### Delete a Call Record from the Outgoing Call History

- Press  (**Redial**). The last number dialed is displayed.

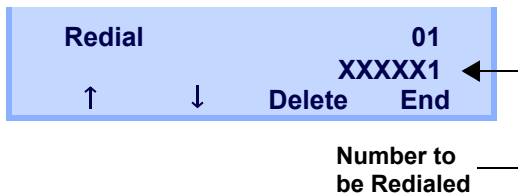

- Press  or **↑/↓** until a desired number is displayed.



- Press **DEL** softkey.

- Press **One** softkey.



### Delete All Records from the Outgoing Call History

- Press  (**Redial**). The last number dialed is displayed.

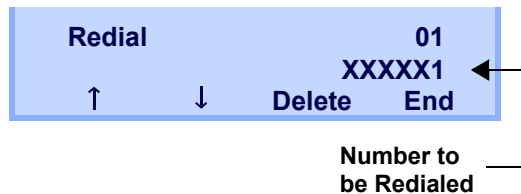

- Press **DEL** softkey.
- Press **All** softkey.



## Voice Call

### Using Soft Key

- Lift handset.
- Dial desired station number; **VOICE** appears

while station is ringing.

3-18 TUE 8:30AM  
CALLING STA 101  
Voice MW VMsg ↓

- (3) Press **VOICE**. Speak to called party.

## Three-Party Conference

- (1) While Station A and Station B are engaged in a Two-party connection, Station A presses **Conf** softkey.

Station A hears Special Dial Tone.

Station B hears the music on hold.

TALKING TO STA 101  
Conf

- (2) Station A dials a desired Station Number (Station C).

Station Number  
of Station C

3-18 TUE 8:30AM  
TALKING TO STA 105  
ADD Rls

- (3) After Station C answers the transferred call, Station A presses **ADD** softkey.

Station Number  
of Station C

3-18 TUE 3:49PM  
ICM Dial CONF  
Begin DIR

- (4) Station A presses the **Begin** softkey.  
(5) Three-Party call is now established.

## Voice Mail System

### ○ Originate

Press the **VMsg** softkey.

## DND (Do Not Disturb)

This feature restricts incoming calls to a terminal.



*This feature is set by Soft key or feature key. The feature key is set using system data setting at initial installation. For details, contact the system administrator.*

### To Set DND

- (1) Press the **Speaker** key.  
The Call Indicator lamp goes off.  
The Speaker key lamp lights red.  
The Line key lamp lights green.
- (2) Press Soft key (>>>>) when Soft key is used.
- (3) Press Soft key (**DND**) or DND feature key.
- (4) Press the **Speaker** key.  
The Speaker key lamp goes off.  
The Line key lamp goes off.

## To Cancel

- (1) Press the **Speaker** key.  
The Call Indicator lamp goes off.  
The Speaker key lamp lights red.  
The Line key lamp lights green.
- (2) Press Soft key (>>>>) when Soft key is used.
- (3) Press Soft key (**DND**) or DND feature key.
- (4) Press the **Speaker** key.  
The Speaker key lamp goes off.  
The Line key lamp goes off.

## How to Input Characters

This section explains how to enter characters on the text input screen such as Name or User ID, etc.

### Character Entry Mode

When entering characters from the telephone set, the following three modes are available: uppercase alphabetical character, lowercase alphabetical character and numeric character. The character entry mode can be changed by pressing  or local soft key 3 "Aa1".

Uppercase Alphabetical Character Mode

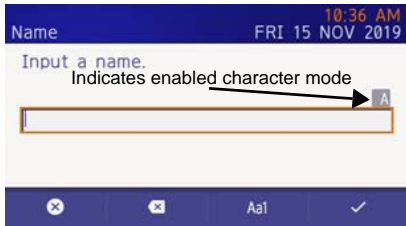

Lowercase Alphabetical Character Mode

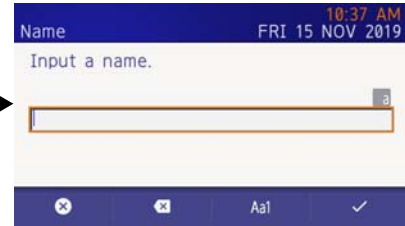

Press the \* key or local soft key 3 Aa1.

Press the \* key or local soft key 3 Aa1.

Numeric Character Mode

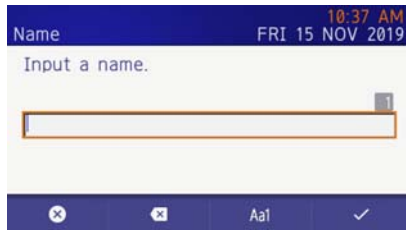

Press the \* key or local soft key 3 Aa1.

## Character Code List

### Character Code for English (1/2)

DIGIT KEY	CASE SHIFT	1st	2nd	3rd	4th	5th	6th	7th	8th	9th	10th	11th	12th	13th
①	A	.	,	\	1	?	!	“	@	:	;			
	a													
②	A	A	B	C	2									
	a	a	b	c	2									
③	A	D	E	F	3									
	a	d	e	f	3									
④	A	G	H	I	4									
	a	g	h	i	4									
⑤	A	J	K	L	5									
	a	j	k	l	5									
⑥	A	M	N	O	6									
	a	m	n	o	6									
⑦	A	P	Q	R	S	7								
	a	p	q	r	s	7								
⑧	A	T	U	V	8									
	a	t	u	v	8									
⑨	A	W	X	Y	Z	9								
	a	w	x	y	z	9								
⑩	A	[SP]	0											
	a													



## Character Code for English (2/2)

		1st	2nd	3rd	4th	5th	6th	7th	8th	9th	10th	
# Note	A	*	#	.	/	:	~	!	@	\$	%	
	a											
			11th	12th	13th	14th	15th	16th	17th	18th	19th	20th
	A	^	&	(	)	'	?	"	-	+	-	
	a											
			21th	22th	23th	24th	25th	26th	27th	28th	29th	30th
	A	=	[	]	{	}	<	>	,	;	\	
	a											
*	Used as a case shift key. Shifts the characters between alphabetical and numeric.											

Note: (#) and (\*) is the same for European languages other than English, including Russian and Turkish.

## Character Code for Russian

DIGIT KEY	CASE SHIFT	1st	2nd	3rd	4th	5th	6th	7th	8th	9th	10th	11th	12th	13th	14th	15th
①	A	.	,	:	!	?	+	-	%	&	/	(	)	=	¿	i
	a															
②	A	А	Б	В	Г											
	a	а	б	в	г											
③	A	Д	Е	Ё	Ж	З										
	a	д	е	ё	ж	з										
④	A	И	Й	К	Л											
	a	и	й	к	л											
⑤	A	М	Н	О	П											
	a	м	н	о	п											
⑥	A	Р	С	Т	У											
	a	р	с	т	у											
⑦	A	Ф	Х	Ц	Ч											
	a	ф	х	ц	ч											
⑧	A	Ш	Щ	Ъ	Ы	Ь										
	a	ш	щ	ъ	ы	ь										
⑨	A	Э	Ю	Я												
	a	э	ю	я												
⑩	A	[SP]														
	a															

Note:    ① and ② is the same for English.  
Refer to the <Character Code For English (2/2)>.

## Character Code for Turkish

DIGIT KEY	CASE SHIFT	1st	2nd	3rd	4th	5th	6th	7th	8th	9th	10th	11th	12th	13th	14th	15th
①	A	.	,	:	!	?	+	-	%	&	/	(	)	=	ı	i
	a															
②	A	A	B	C	Ç											
	a	a	b	c	ç											
③	A	D	E	F												
	a	d	e	f												
④	A	G	Ğ	H	I	İ										
	a	g	ğ	h	I	i										
⑤	A	J	K	L												
	a	j	k	l												
⑥	A	M	N	O	Ö											
	a	m	n	o	ö											
⑦	A	P	R	S	Ş											
	a	p	r	s	ş											
⑧	A	T	U	Ü	V											
	a	t	u	ü	v											
⑨	A	Y	Z													
	a	y	z													
⑩	A	[SP]														
	a															

Note:      Ⓝ and Ⓢ is the same for English.  
Refer to the <Character Code For English (2/2)>.

## Character Code for European Languages Other Than English

DIGIT KEY	CASE SHIFT	1st	2nd	3rd	4th	5th	6th	7th	8th	9th	10th	11th	12th	13th	14th	15th
①	A	.	,	:	!	?	+	-	%	&	/	(	)	=	¿	i
	a															
②	A	A	B	C	À	Á	Â	Ã	Ä	Å	Æ	Ç				
	a	a	b	c	à	á	â	ã	ä	å	æ	ç				
③	A	D	E	F	È	É	Ê	Ë								
	a	d	e	f	è	é	ê	ë								
④	A	G	H	I	Ì	Í	Î	Ï								
	a	g	h	i	ì	í	î	ï								
⑤	A	J	K	L												
	a	j	k	l												
⑥	A	M	N	O	Ñ	Ò	Ó	Ô	Õ	Ö	Ø	∅				
	a	m	n	o	ñ	ò	ó	ô	õ	ö	ø	∅				
⑦	A	P	Q	R	S	ß										
	a	p	q	r	s	ß										
⑧	A	T	U	V	Û	Ü	Û	Ü								
	a	t	u	v	û	ü	û	ü								
⑨	A	W	X	Y	Z											
	a	w	x	y	z											
⑩	A	[SP]														
	a															

Note: ① and ② is the same for English.  
Refer to the <Character Code For English (2/2)>.

## Number Code

DIGIT KEY	CASE SHIFT	1st	2nd	3rd	4th	5th	6th	7th	8th	9th	10th	11th	12th	13th	14th	15th
①	1	1														
②	1	2														
③	1	3														
④	1	4														
⑤	1	5														
⑥	1	6														
⑦	1	7														
⑧	1	8														
⑨	1	9														
⑩	1	0														
#	1	*	#	.	@	/	(	)	,	-	_	:	'	~	&	\
*	1	Used as a case shift key. Shifts the characters between alphabetical and numeric.														

**Note:** \* When entering password, "0-9", "\*" and "#" are available.

"#" is entered by pressing #.

"\*" is entered by pressing \*.

## Character Entry Method

The following example of character entry shows how to enter “Ken Kobus”.

- (1) Press **5** twice to enter “K”.
- (2) Press **2** “\*” or local soft key 3 “Aa1” to switch the text input mode from uppercase to lowercase.
- (3) Enter “en” by using digit keys.  
Press **3** twice to enter “e”.  
Press **6** twice to enter “n”.
- (4) Press **0** once to enter a space.
- (5) Press **2** “\*” or local soft key 3 “Aa1” to switch the text input mode from lowercase to uppercase.
- (6) Press **5** twice to enter “K”.
- (7) Press **2** “\*” or local soft key 3 “Aa1” to switch the text input mode from lowercase to uppercase.
- (8) Enter “obus” by using digit keys.  
Press **6** three times to enter “o”.  
Press **2** twice to enter “b”.  
Press **8** twice to enter “u”.  
Press **7** four times to enter “s”.
- (9) Press  (Enter) or **OK**.

## Security Mode

DT930 has a Security mode which prevents unauthorized access and information leakage from the terminal. It can be used by assigning functions to a programmable key. The key LED lights up while the terminal is locked.

**Note:** When the System Administrator invalidates the security mode, this function cannot be used. For details of the security mode, contact the System Administrator.

**Note:** After a third attempt (if uncorrected password is entered three times consecutively), the telephone locks up, and any key operation will be disabled for 10 minutes.

**Note:** While the telephone is locked,  becomes disabled. Also, any features provided by the telephony server, such as call origination or call answering, cannot be performed.

**Note:** Even when the telephone is reset for any reason (such as power-off, etc.) while the telephone is placed in security mode, the lock is not released.

- (1) Enter the password and press  (Enter) or **OK**.  
Security.

### TIP

When the password entry ends in failure, the following error message is issued. In that case, press



or **OK** and retry.

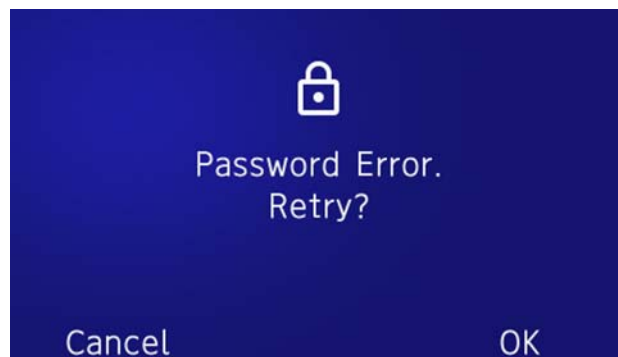

## TIP

After a third attempt (if incorrect password is entered three times consecutively), the following error message is issued. Press  or **OK**. The telephone locks up, and any key operation will be disabled for 10 minutes. Wait for 10 minutes, make a retry. Please note emergency calls cannot be completed during the 10 minutes terminal lock out period.

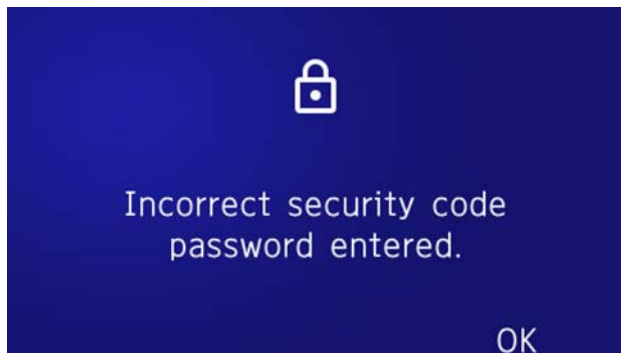

## Phonebook

### System Phonebook

The System Phonebook is used on a system basis. The data entry is made by the Telephony Server Administrator.

### Available Characters in Local Phonebook

The following tables show the characters available in the Local Phonebook.

## Uppercase Character

Digit Code	1	2	3	4	5	6	7	8	9	0	*	#
Character	.	A	D	G	J	M	P	T	W	SP	*	#
	,	B	E	H	K	N	Q	U	X	0		
	:	C	F	I	L	O	R	V	Y			
	!	À	É	Ì	5	Ñ	S	Ü	Z			
	?	Á	Ê	Í		Ò	β	Ú	9			
	-	Ä	Ë	Ï		Ó	7	Û				
	+	Å	Ë	Ï		Ö		Ü				
	%	Ä	3	4		Ö		8				
	&	Ä				Ö						
	/	Æ				Œ						
	(	Ç				Ø						
	)	2				6						
	=											
	¿											
	¡											
1												

SP: Blank Space



## Lowercase Character

Digit Code	1	2	3	4	5	6	7	8	9	0	*	#
Character	.	a	d	g	j	m	p	t	w	SP	*	#
	,	b	e	h	k	n	q	u	x	0		
	:	c	f	i	l	o	r	v	y			
	!	à	è	ì	5	ñ	s	ù	z			
	?	á	é	í		ò	β	ú	9			
	:	â	ê	î		ó	7	û				
	\	ä	ë	ï		ô		ü				
	"	å	3	4		õ		8				
	@	æ				ö						
	1	ç				6						
		2										

SP: Blank Space

# 7. FAVORITE SCREEN OPERATION

## Favorite Screen

On the favorite screen, short cut icons that you registered are displayed. Calls can be easily made by using registered numbers which are frequently used. Also, it is possible to access the service URL quickly.

The following four types of shortcuts are available. A maximum of eight shortcuts can be registered.

- The contact person is registered in the SV9100 Internal Extension List.
- Telephone number which is frequently dialed (maximum of 16 digits).
- The service menu button provided by the XML application.
- Redial button.



Even if you register the service shortcut, the URL must be registered in the configuration setting or it cannot be used. For details, contact the system administrator.

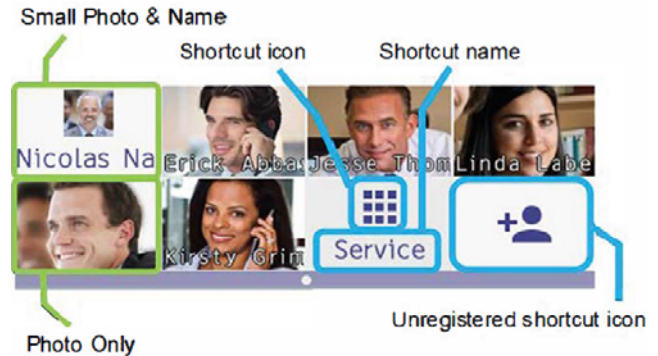

There are three types of Shortcut Photo & Name settings:

- *Small Photo and Name*  
Displays the photo registered in the contact in a small size, and displays the shortcut name below the photo.
- *Photo and Name*  
Displays the photo registered in the contact in a large size, and displays the shortcut name over the photo.
- *Photo Only*  
Displays the photo registered in the contact in a large size. Shortcut name is not displayed.

For settings refer to [To Change Shortcut Display](#).

## How to Select a Shortcut

Use the cursor keys to move the orange focus to the desired shortcut and press the **Enter** key.

An orange frame indicates the location of the focus. It can be moved left, right, up or down using the cursor.

An orange frame indicates the location of the focus. It can be moved to left, right, up or down by cursor operation.

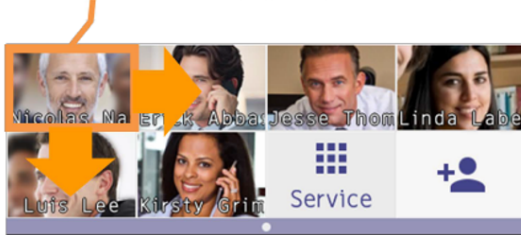

## Shortcut Icon

The following icons are displayed with every type of shortcut.

- Contact person: The picture registered in the SV9100 Internal Extension List.
- Telephone number: The icon picture chosen at the time of the shortcut registration.



○ Service: 

○ Service 1~4: 

○ Redial: 

○ Unregistered Shortcut: 

## Shortcut Name

The following names are displayed with every type of shortcut.

- Contact person: The name registered in the SV9100 Internal Extension List.
- Telephone number: The name input at the time of the shortcut registration.
- Service: "Service" is displayed.
- Service 1 ~ 4: The name selected during shortcut registration.
- Unregistered shortcut: It is not indicated.

A short cut name consists of approximately 10 characters. It depends on the character string when the character string is cut.

## To Register a Shortcut

The following explains how to register a shortcut. For example, when registering a telephone number that is used frequently.

### (1) Select an **Unregistered Shortcut**.

Select the Unregistered Shortcut to register the number.

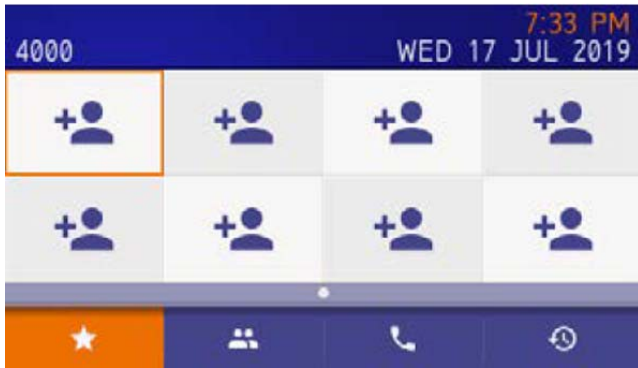

*Use the cursor keys to move the orange focus to the desired shortcut and press the **Enter** key.*

### (2) Select **Dial**.



### (3) Input the desired **number**.

From one to a maximum of 16 characters can be registered.

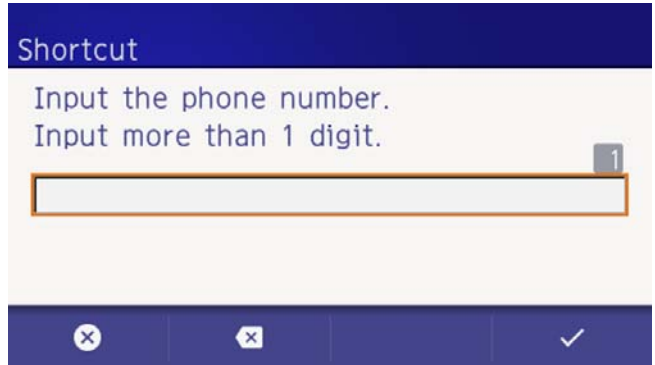

(4) Input the desired shortcut **name**.

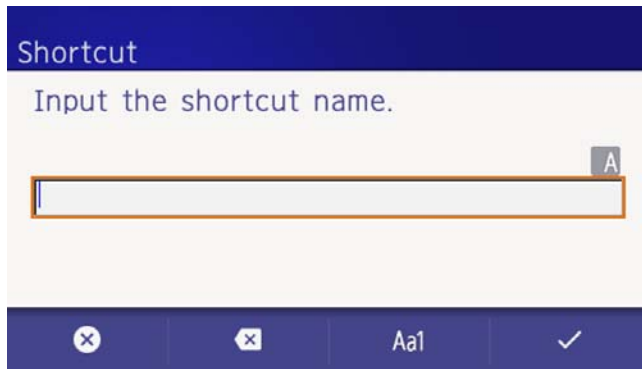

(5) Select desired shortcut **icon**.

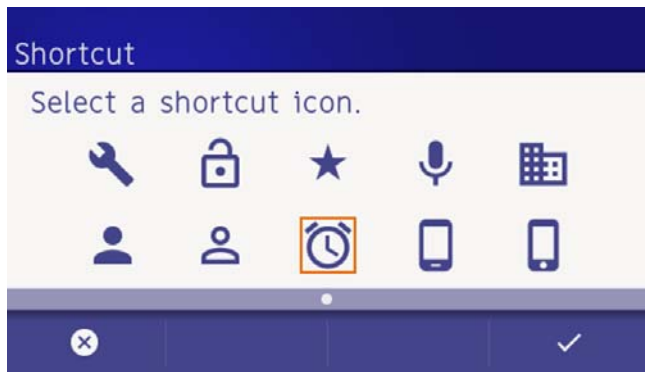

(6) The registered shortcut is added.



After a moment, the input character and selected icon is displayed.

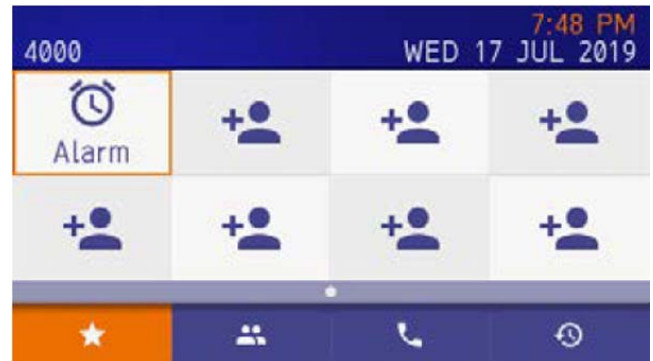

## To Use the Shortcut

The following explains how to use a shortcut when calling the contact person registered in the SV9100 Internal Extension List.

(1) Select the **registered shortcut**.

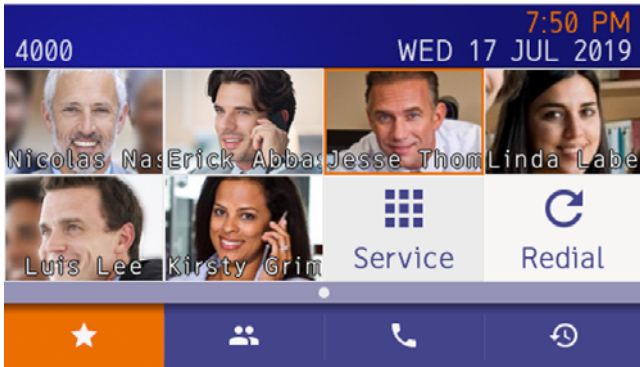

Use the cursor keys to move the orange focus to the desired shortcut and press the **Enter** key.

(2) The profile screen is displayed.

A call can be made to the person by pressing local soft key 2. You can also call by picking up the handset and pressing the **Speaker** or **Enter** key.

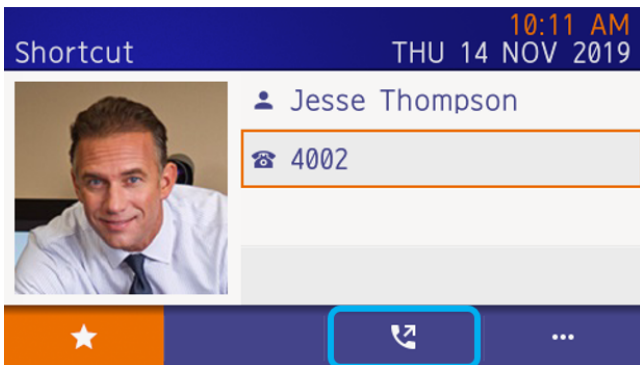

Verify the focus is pointed to the number to be dialed. If the focus does not point to the number, the call cannot be made.

### **To add and send a prefix:**

Use the cursor keys to move the orange focus to desired shortcut and press the **Enter** key.

Press Soft key 3  (Option) on the profile screen.

Select **1** **Prefix**.

For prefix number setting information, refer to [To Set Prefix](#).

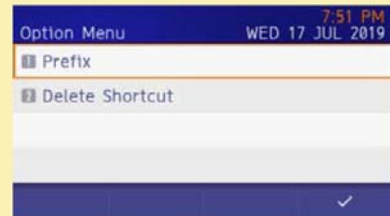

Select the prefix number to be added.  
Press local Soft key 4.

The number can be called using a prefix or, by picking the handset up and pressing the **Speaker** or **Enter** key.



(3) The calling screen is displayed.

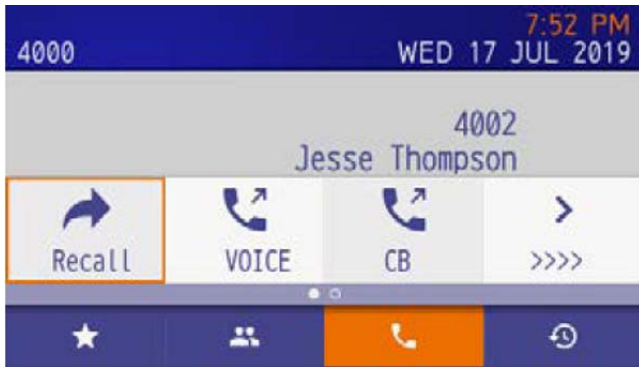

When conversation with the calling party starts, the following screen is displayed.

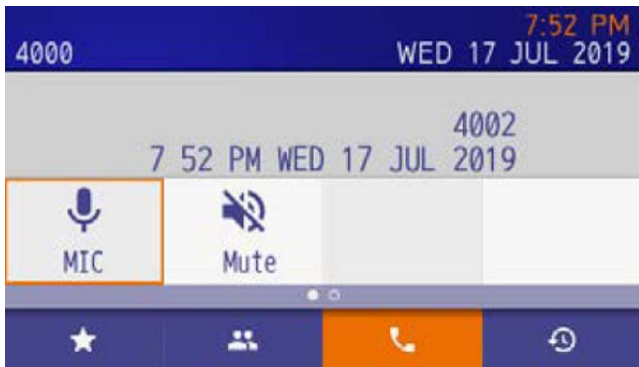

(4) End the call.

End the call by replacing the handset or pressing the speaker key.



To upload an image to a shortcut, refer to the Appendix [To Upload an Image](#).



**If using the dial shortcut:**

If the feature code is registered as a shortcut, press the **Speaker** key or pick up the **handset** to make a call from the shortcut. The **Enter** key or **Speaker** key is not available.

## To Edit the Shortcut

You can edit the registered shortcut information.



In this function, the information can only be edited that is set at the shortcut registration. You can replace the contact on the edit screen of a contact person shortcut, but cannot edit the contact information.

Also, the shortcut types cannot be edited using this method. To change the shortcut type, delete the shortcut and register again. For register or delete shortcut, refer to [To Register a Shortcut](#) or [To Delete Shortcut](#).



The Redial shortcut cannot be edited.

- (1) Select a registered shortcut.  
Select a registered shortcut using a long press.
- (2) Select **Edit Shortcut**.  
The option menu is displayed, select "Edit shortcut".
- (3) Select data.  
Data select screen is displayed. Select data that needs to be edited.

- (4) Edit the data.  
Edit the registered information, and press **Enter** or the local soft key **4**.
- (5) The information is refreshed.  
If editing is completed, the following screen is displayed, and the screen returns to the Favorite screen after a second.

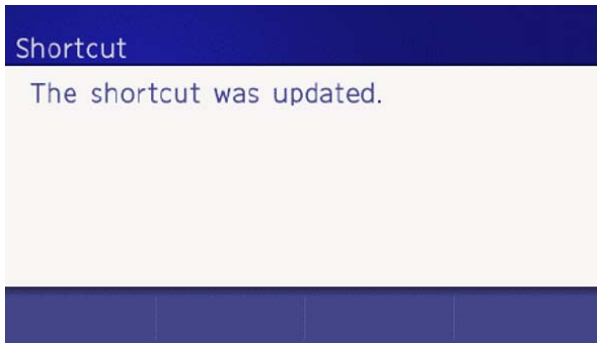

## To Delete Shortcut

There are two ways to delete shortcuts. One is from a registered favorite screen, the other is from user settings. From the user menu, it is possible to delete some shortcuts, or all shortcuts from user settings.

### From a Registered Shortcut

The following explains how to delete shortcuts one by one. For example, deletion of a SV9100 Internal Extension List user shortcut or dial number shortcut is shown below.

- (1) Select a registered shortcut.



*Use the cursor keys to move the orange focus to the desired shortcut and press the **Enter** key.*

- (2) Open the option menu.
- (3) Select **2 Delete Shortcut**.
- (4) Confirm the deletion.  
Press **Enter** or local Soft key **4**.

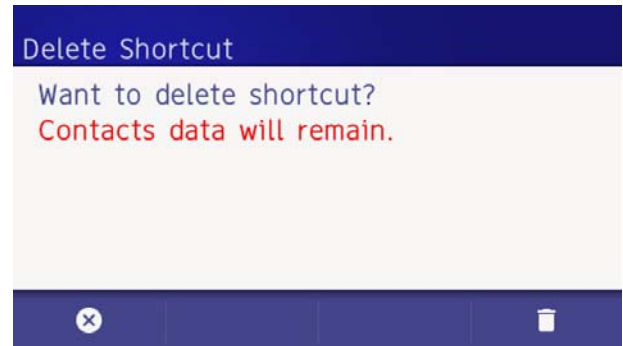

- (5) Shortcut is deleted from favorite screen.  
When shortcut deletion is completed, the following is displayed.

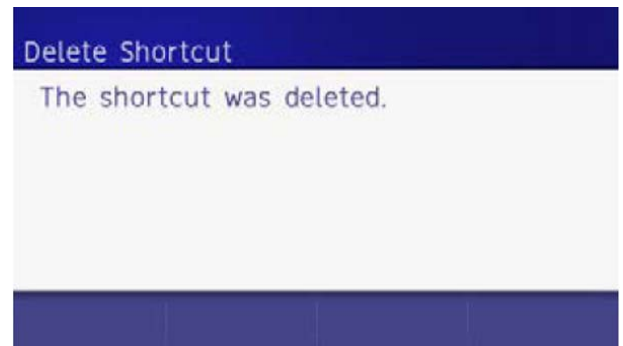



After a moment the favorite screen is displayed.

## From User Settings

- (1) From the Menu screen select **Settings**.

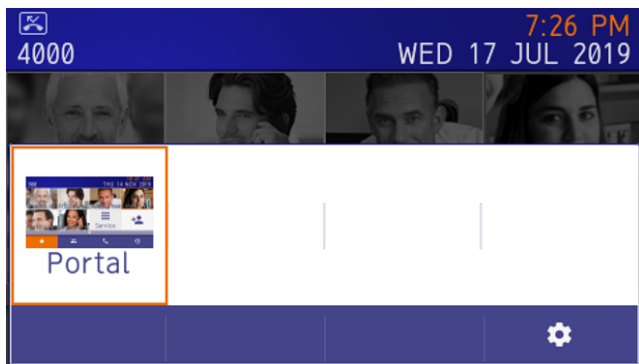

- (2) Display the delete shortcut menu.
  - Select **1** **User Settings**
  - Select **3** **Display**
  - Select **7** **Portal Mode Setting**
  - Select **1** **Delete Shortcut**
- (3) Select shortcut to be deleted.

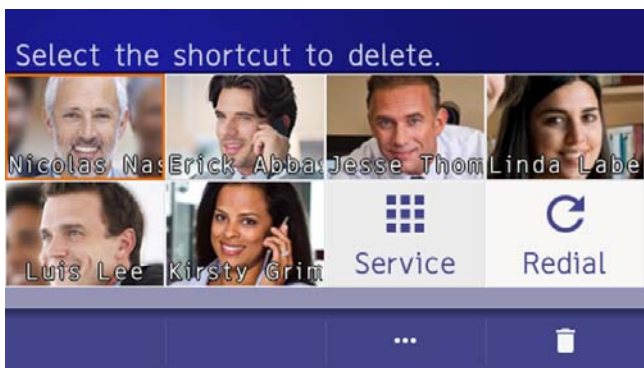

Use the cursor keys to move the orange focus to the desired shortcut and press the **Enter** key.

**To delete all shortcuts:**  
Select option with Soft key 3.

Select **1** **Delete All**.

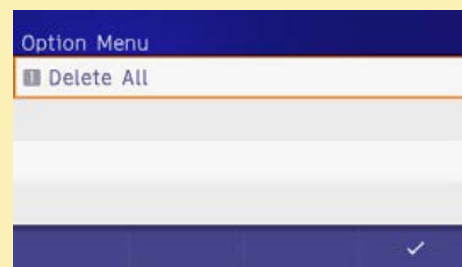

Confirm all delete.  
To Cancel, press **Back** key.

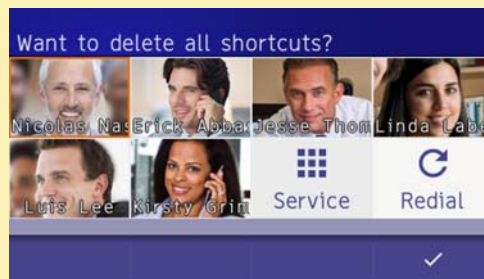

- (4) The shortcut is deleted from the favorite screen.  
When the shortcut is successfully deleted, the following is displayed.

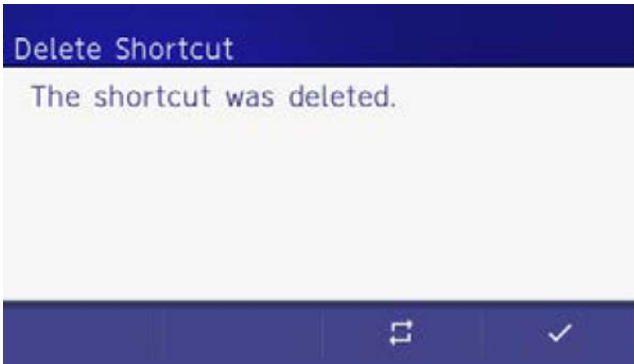

- (5) To delete more shortcuts, press Soft key **3**. Then displayed operation 3.

## To Change Shortcut Display

The following explains how to change the display for shortcuts on the Favorite screen.

- (1) From the **Menu** screen, and select **Settings**.

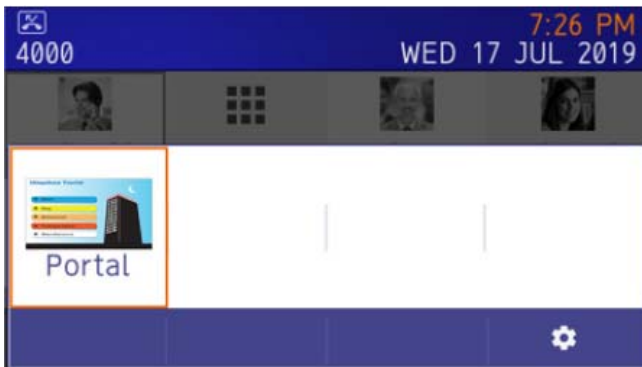

- (2) Display **Shortcut Photo & Name**.

- (3) Select **1** (User Settings).  
 (4) Select **3** (Display).  
 (5) Select **7** (Portal Mode Setting).  
 (6) Select **5** (Shortcut Photo & Name).  
 (7) Select a desired display method.





*The default setting is **2**, Photo & Name.*

# 8. DIRECTORY OPERATION

This chapter explains the DT930 Directory features.

## Add New Data

- (1) Press the  key.

When the menu screen is displayed. Select **Directory** then press  (**Enter**) or **OK** softkey (or press the **2** key)  
Or, press the following softkeys in the order listed:  
↓ **Prog** ↑ **TELBK**).

- (2) Select **1** : **REGIST** and then press  (**Enter**) or press **1** key.

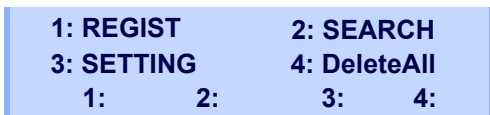

1: REGIST      2: SEARCH  
3: SETTING     4: DeleteAll  
1:            2:            3:            4:

- (3) Select Name or Telephone Number by using Alphabet or Num softkey to toggle between the two.

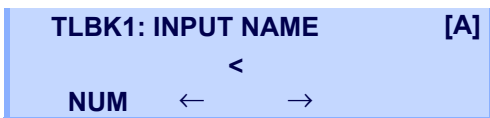

TLBK1: INPUT NAME [A]  
NUM ← →

- (4) Enter a name or telephone number to be registered in the directory using the dial pad.

- (5) After entering the name or telephone, press the  key.

*Note:* The **Feature** key can be used to backspace and delete a character.

- (6) The following list appears. Select a desired group by entering a number.

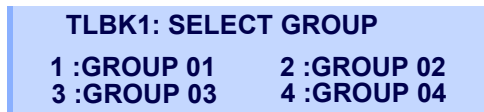

TLBK1: SELECT GROUP  
1 :GROUP 01    2 :GROUP 02  
3 :GROUP 03    4 :GROUP 04

- (7) Enter the telephone number as indicated in the display and press the  key.

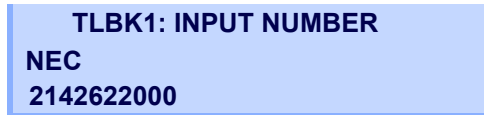

TLBK1: INPUT NUMBER  
NEC  
2142622000

- (8) Enter a desired Memory ID.





TLBK1: REGIST MEMORY  
>000  
[0-299]

- (9) After entering the Memory ID, the display goes back to the main directory screen. Press the **Exit** key.

## Find Registered Data

- (1) Press the  key.

When the menu screen is displayed. Select **Directory** then press  (**Enter**) or **OK** softkey (or press the **2** key)  
Or, press the following softkeys in the order listed:  
↓ **Prog** ↑ **TELBK**).

- (2) Select **2**: **Search** then press  (**Enter**) or press **2** key.

<b>1: REGIST</b>	<b>2: SEARCH</b>
<b>3: SETTING</b>	<b>4: DeleteAll</b>
<b>1:</b>	<b>2:</b>
<b>3:</b>	<b>4:</b>

*Note:* The display will show No TELBK Data if there are no entries to review.

<b>TLBK1: SEARCH NAME</b>	<b>[A]</b>
<b>&lt;</b>	
<b>NUM</b>	<b>MENU</b>

- (3) Select a search method from the following list.

<b>[SEARCH MENU]</b>			
<b>NAME</b>	<b>GRP</b>	<b>NUM</b>	<b>MEM</b>

KEY	DESCRIPTION
Name	Search data from the name list registered in the directory.
Group	Display the lists registered to each group (01~20 groups).
Tel Number	Search data from the telephone number list registered in the directory.
Memory ID	Search data from the memory number registered in the directory.

- (4) The following is an example when NAME, GRP, NUM, and MEM are selected as a search.

NAME

<b>TLBK1: SEARCH NAME</b>	<b>[A]</b>
<b>&lt;</b>	
<b>NUM</b>	<b>MENU</b>
<b>←</b>	<b>→</b>

GRP

<b>TLBK1: SEARCH GROUP</b>	
<b>1 :GROUP 01</b>	<b>2 :GROUP 02</b>
<b>3 :GROUP 03</b>	<b>4 :GROUP 04</b>

NUM

<b>TLBK1: SEARCH NUMBER</b>	<b>&lt;</b>
<b>MENU</b>	

MEM

<b>TLBK1: SEARCH MEMORY</b>	
<b>MENU</b>	<b>&gt;</b>
	<b>[0-299]</b>

## Make a Call from Directory

**Note:** While the Directory screen is being displayed, you cannot make a call by dialing a telephone number.

- (1) Press the  key.

When the menu screen is displayed. Select **Directory** then press  (**Enter**) or **OK** softkey (or press the **2** key)

Or, press the following softkeys in the order listed:  
↓ **Prog** ↑ **TELBK**).

- (2) Select **[2]: Search** then press  (**Enter**) or press **[2]** key.

<b>1: REGIST</b>	<b>2: SEARCH</b>
<b>3: SETTING</b>	<b>4: DeleteAll</b>
<b>1:</b>	<b>2:</b>
<b>3:</b>	<b>4:</b>

**Note:** The display will show No TELBK Data if there are no entries to review.

<b>TLBK1: SEARCH NAME</b>	<b>[A]</b>
<b>&lt;</b>	
<b>NUM</b>	<b>MENU</b>

- (3) Select a search method (e.g., NAME, GRP, NUM or MEM).

<b>[SEARCH MENU]</b>			
<b>NAME</b>	<b>GRP</b>	<b>NUM</b>	<b>MEM</b>

The following display is an example of dial by name.











<b>[1]</b>	<b>NEC</b>
<b>2142622000</b>	
<b>CHG</b>	<b>DEL Dial</b>

- (4) Lift the **Handset**, press the  key or MIC key or press the **Dial** softkey while displaying the detailed data for target party on LCD.

**Note:** If multiple telephone numbers are assigned into a target party, a call is made to the first telephone number.

## To Set Prefix

When making a call, a prefix can be added to telephone numbers to be dialed. Prefixes need to be set in advance.



- (1) Press the  key. The menu screen is displayed.
- (2) Select **Settings**.
- (3) Select **[1] User Settings** then press  (**Enter**),  (**Right-cursor**) or press **[1]** key.
- (4) Select **[2] Talk** then press  (**Enter**),  (**Right-cursor**) or press **[2]** key.
- (5) Select **[5] Prefix** then press  (**Enter**),  (**Right-cursor**) or press **[5]** key.
- (6) Select **[1] Prefix** then press  (**Enter**),  (**Right-cursor**) or press **[1]** key.
- (7) Enter a prefix using the digit keys. After entering the prefix press  (**Enter**).

- (8) The display returns to the Prefix screen. Refer to (6) on page 139. If multiple prefixes need to be set, repeat (6) and (7). In that case, select **2** **Prefix 2** and **3** **Prefix 3**.

*Note:* A maximum of 10 digits (0-9, \* and #) can be set as a prefix.

*Note:* When prefix is added, a maximum of 32 digits including the prefix can be sent as a dial number.

## Delete All Data

- (1) Press the <sup>Menu</sup>  key. The menu screen is displayed.
- (2) Select **Directory** then press  (**Enter**) or press **2** key.
- (3) Select **4** : **DeleteAll** then press  (**Enter**) or press **4** key.

<b>1: REGIST</b>	<b>2: SEARCH</b>
<b>3: SETTING</b>	<b>4: DeleteAll</b>
<b>1:</b>	<b>2:</b>
<b>3:</b>	<b>4:</b>

The following is a sample display of a deleted number:



<b>TLBK1: DELETE ALL DATA</b>
<b>INPUT PWD: 4DIGIT</b>

- (4) After 4-digit password is entered, display asks if you want to delete all directory data. To delete, press **Yes**.

- (5) After the appropriate directory data is deleted, the following is displayed.

<b>DELETED ALL TELBOOK DATA</b>
---------------------------------

## Delete Specific Directory Data

- (1) Press the <sup>Menu</sup>  key. The menu screen is displayed.
- (2) Select **Directory** then press  (**Enter**) or press **2** key.
- (3) Select **2** : **Search** then press  (**Enter**) or press **2** key.

<b>1: REGIST</b>	<b>2: SEARCH</b>
<b>3: SETTING</b>	<b>4: DeleteAll</b>
<b>1:</b>	<b>2:</b>
<b>3:</b>	<b>4:</b>

*Note:* The display will show No TELBK Data if there are no entries to review.

<b>TLBK1: SEARCH NAME</b>	<b>[A]</b>
<b>&lt;</b>	
<b>NUM</b>	<b>MENU</b>

- (4) Select a search method (e.g., NAME, GRP, NUM or MEM).

<b>[SEARCH MENU]</b>			
<b>NAME</b>	<b>GRP</b>	<b>NUM</b>	<b>MEM</b>

- (5) With the cursor key or softkey select the search method to be used.
- (6) Select a specific group to be deleted (e.g., Group 01).

**1: NEC**  
**2142622000**

- (7) Select **1: NEC**.

**[1] NEC**  
**2142622000**  
**CHG DEL Dial**

- (8) Press the **DEL** softkey to delete the appropriate directory data.
- (9) After the appropriate directory data is deleted, the following display appears. Confirm delete by pressing **Yes**.

**TLBK1: DELETE DATA**  
**DELETE DATA?**  
**Yes No**

- (10) The following confirmation message appears.

**DELETE COMPLETE!**

This page is for your notes.



# 9. CALL HISTORY OPERATION

This chapter explains Call History of DT930. By using Call History, you can make a call with simple operation. Call History allows the telephone to register up to 50 records into its memory. If the number of registered records exceeds 50, a record will be deleted in order of occurrence.

**Note:** Register Call History data to Personal Directory as necessary. Call History data will be cleared when powering off the telephone.

However, Call History data can be backed up to your PC. About Backup/Restore, see *Backup Personal Settings* or *Restore Personal Settings* in 3.TERMINAL SETUP – CLASSIC.

**Note:** The Call History data that is stored in the memory of each telephone cannot be added to Phonebook (both System Phonebook and Local Phonebook) controlled by the system.

**Note:** On the Menu screen, use  or  $\uparrow/\downarrow$  softkey to move the cursor up/down a line.

## To View Call History

- Press the  key.

When the menu screen is displayed, select **History**, then press  (**Enter**) or the **OK** softkey (or press  $\mathbf{1}$  key). Or, press the **List** softkey.

- Display an item from the history by pressing the **CID** softkey.

### LIST MENU

Redial      CID

- Detailed information of the last call is displayed.



01:		2142622000
$\uparrow$	$\downarrow$	2-9    10:42
		Store    DEL

**Note:** Use the Cursor key to display the next/former records.

**Note:** If no history data is saved, "LIST END" will be displayed on the LCD.

## To Make a Call from Call History

**Note:** While the history data is displayed, you cannot make a call by dialing a telephone number.

- Press the  key. The menu screen is displayed.
- Select  $\mathbf{1}$ : **History** then press  (**Enter**) or press  $\mathbf{1}$  key.
- Press the **Redial** softkey.

### LIST MENU

Redial      CID



# Appendix A. Menu List

## Menu List: DT930 (ITK-24CG-1)

Menu Item	Description
Menu	Press  to display the <b>Menu</b> screen.
History	Select this option to view the Call History data. Also, you can add the history data to the directory.
Directory	Select this option to access the directory feature. There are the following three types of directory features: Personal Directory, Phonebook and Corporate Directory. This chapter explains the menu list for Personal Directory feature.
Service	Select this option to display the screen of XML application/Photo Frame application registered in the service URL.
Setting	Select this option to make the user setting of DT930.
Portal	Select this option to display XML application screen registered in the home URL.

### Menu List for **History**

Menu Item	Description	Default Value
History	System history.	–

### Menu List for **Directory**

Menu Item	Description	Default Value
Directory	Directory history.	–

## Menu List for **Setting - Classic Mode**

Menu Item		Description	Default Value
Setting			
1	User Setting	Select this option to configure the user setting of DT930.	–
	1 Incoming Call	Select this option to set up for incoming calls.	–
	1 Offhook Ring	Select this option to specify whether to use the Off-hook ringing.	Enable
	2 Headset Ring	Select this option to specify whether to use the headset ringing.	Disable
	3 Ring Tone	Select a ringer tone for External Call and Internal Call. (Automatic / Tone Type 1~14 / Download 1~3)	Automatic (Tone Type 1)
	4 Illumination	Select this option to set the illumination pattern for External Call and Internal Call. (Automatic / Disable / Red / Green / Blue / Yellow / Purple Light Blue / White / Rotation)	Automatic (Red)
2	Talk	Select this option to set up for telephone conversation.	–
	1 RTP Alarm	Select this option to specify whether to use the RTP alarm.	Automatic
	2 DTMF Tone	Select this option to specify whether to use the DTMF tone.	Automatic
	3 Key Touch Tone	Select this option to set the key touch tone generated when the digit keys are pressed while the telephone is off-hook.	Automatic (Tone)
	4 Hold Music	Select a Music on Hold to be heard by DT930 user.	Default
	5 Prefix	Select this option to register a Prefix number.	–
3	Display	Select this option to set up for the LCD display.	–
	1 Calendar Format	Set calendar display format and time display format.	Automatic (12-hour format)
	2 Local Volume	Specify whether to display the following volume levels: handset receiver volume, speaker volume, ringer tone volume and LCD contrast.	Automatic (Enable)
	3 Screen Saver	Select this option to set up Screen Saver related data.	–
	1 Screen Saver Mode	Select this option to specify whether to use a Screen Saver.	Enable
	2 Wait Time	Select this option to specify the Wait Time to launch a Screen Saver.	30 min

Menu Item		Description	Default Value
	4 Back Light	Select this option to set the brightness of the backlight. 1. Level 1 (Bright) ~ 4. Level 4 (Dark)	Level 2
	5 Font Size	Select this option to change the font size displayed on an LCD.	Standard
	1 Large		
	2 Standard		
	6 Language	Select this option to select a language to be displayed on an LCD.	Automatic
	7 Advanced	Select this option to set up for the following additional data.	–
	1 Wallpaper <i>Note: Wallpaper is not supported at this time.</i>	Select this option to specify the Home screen background (default/download)	Default
	2 Font Color	Select this option to specify the font color for the Time Display/Feature Information Display area. *You can check the color by selecting each color number. (Color 1 ~ Color 16)	Color 16
	3 Turn Off Display	Select this option to specify the data when turning off the display automatically.	–
	1 Turn Off Display Mode	Select this option to set up for Turn Off Display Mode. (Disable/Enable/App Priority)	App Priority
	2 Wait Time	Select this option to specify the time until turning off the display. (1-999 min.)	180 min
	4 Backlight Fade Control	Select this option to specify whether Backlight Fade Control is in service, when turning on/off the backlight of the LCD. (Disable/Enable)	Enable
	4 Change Password	Select this option to change the password to lock/unlock the telephone.	0000
	5 Security	Not used.	–

Menu Item		Description	Default Value	
6 Usability		Select this option to set up for the operation of the Help key while Pop-up window is displayed.	–	
	1. Help Key Mode	Select this option to set up for Help Key Mode (1 SubMenu/2 Popup Window).	SubMenu	
0 Setting Reset		Select this option to reset the telephone settings.	–	
2 Download		Set the data required when downloading a file.	–	
1 Download Files		Select this option to download files for Music on Hold, ringer tone, Directory and Wallpaper.	–	
1	1 Hold Music	Select this option to download a file for Music on Hold.	MOH.wav	
	2 Ring Tone		Select this option to download files for ringer tones (Download 1 to 3).	–
	2	1 Music Ring 1	Select this option to download a file for ringer tone (Download 1).	Melody1.wav
		2 Music Ring 2	Select this option to download a file for ringer tone (Download 2).	Melody2.wav
		3 Music Ring 3	Select this option to download a file for ringer tone (Download 3).	Melody3.wav
	3 Directory		Select this option to download the directory files.	Directory.csv
	4 Wallpaper <i>Note: Wallpaper is not supported at this time.</i>		Select this option to download a file for Wallpaper.	WallPaper.bmp
2 Download Address		Select this option to enter an IP address of the FTP/TFTP/HTTPS server.	0.0.0.0	
3 Protocol		Select this option to specify a protocol of the server (either FTP or TFTP or HTTPS).	FTP	
4 Account Settings		Select this option to set necessary data when using FTP or HTTPS service.	–	
1	1 User ID	Select this option to enter a user ID for downloading via FTP or HTTPS server.	–	
	2 Password	Select this option to enter a password for downloading via FTP or HTTPS server.	–	
	3 Folder	Select this option to specify the directory where the downloaded file is stored.	–	

Menu Item		Description	Default Value
	3 Data Backup/Restore	Select this option to set the data required for a file backup/restore.	–
	1 Data Backup	Select this option to specify the file name to be backed up.	PersonalData.tgz
	2 Data Restore	Select this option to specify the file name to be restored.	PersonalData.tgz
	3 Server Address	Select this option to enter an IP address of the FTP/TFTP/HTTPS server.	0.0.0.0
	4 Protocol	Select this option to select a protocol of the server (either FTP, TFTP or HTTPS).	FTP
	5 Account Settings	Select this option to set necessary data when using FTP or HTTPS server.	–
	1 User ID	Select this option to enter a user ID for the data backup via FTP or HTTPS server.	–
	2 Password	Select this option to enter a password for data backup via FTP or HTTPS server.	–
	3 Folder	Select this option to specify the destination directory of FTP or HTTPS server.	–

## Menu List for **Setting - Portal Mode**

Menu Item		Description	Default Value
Setting			
1	User Setting	Select this option to configure the user setting of DT930.	–
	1 Incoming Call	Select this option to set up for incoming calls.	–
	1 Offhook Ring	Select this option to specify whether to use the Off-hook ringing.	Enable
	2 Headset Ring	Select this option to specify whether to use the headset ringing.	Disable
	3 Ring Tone	Select a ringer tone for External Call and Internal Call. (Automatic / Tone Type 1~14 / Download 1~3)	Automatic (Tone Type 1)
	4 Illumination	Select this option to set the illumination pattern for External Call and Internal Call. (Automatic / Disable / Red / Green / Blue / Yellow / Purple Light Blue / White / Rotation)	Automatic (Red)
2	Talk	Select this option to set up for telephone conversation.	–
	1 RTP Alarm	Select this option to specify whether to use the RTP alarm.	Automatic
	2 DTMF Tone	Select this option to specify whether to use the DTMF tone.	Automatic
	3 Key Touch Tone	Select this option to set the key touch tone generated when the digit keys are pressed while the telephone is off-hook.	Automatic (Tone)
	4 Hold Music	Select a Music on Hold to be heard by DT930 user.	Default
	5 Prefix	Select this option to register a Prefix number.	–
3	Display	Select this option to set up for the LCD display.	–
	1 Calendar Format	Set calendar display format and time display format.	Automatic (12-hour format)
	2 Local Volume	Specify whether to display the following volume levels: handset receiver volume, speaker volume, ringer tone volume and LCD contrast.	Automatic (Enable)
	3 Screen Saver	Select this option to set up Screen Saver related data.	–
	1 Screen Saver Mode	Select this option to specify whether to use a Screen Saver.	Enable
	2 Wait Time	Select this option to specify the Wait Time to launch a Screen Saver.	30 min



Menu Item		Description	Default Value
	4 Back Light	Select this option to set the brightness of the backlight. 1. Level 1 (Bright) ~ 4. Level 4 (Dark)	Level 2
	5 Language	Select this option to select a language to be displayed on an LCD.	Automatic
	6 Advanced	Select this option to set up for the following additional data.	–
	1 Turn Off Display	Select this option to specify the data when turning off the display automatically.	–
	1 Turn Off Display Mode	Select this option to set up for Turn Off Display Mode. (Disable/Enable/App Priority)	App Priority
	2 Wait Time	Select this option to specify the time until turning off the display. (1-999 min.)	180 min
	2 Backlight Fade Control	Select this option to specify whether Backlight Fade Control is in service, when turning on/off the backlight of the LCD. (Disable/Enable)	Enable
	7 Portal Mode	Select this option to set up for the following about Portal mode.	–
	1 Delete Shortcut	Select this option to delete shortcut.	–
	2 Change Theme	Select this option to set up for Display theme	White Theme
	1 White Theme	Select this option to set theme to White	–
	2 Black Theme	Select this option to set theme to Black	–
	4 Change Password	Select this option to change the password to lock/unlock the telephone.	0000
	5 Security	Not used.	–

Menu Item		Description	Default Value
	6 Usability	Select this option to set up for the operation of the Help key while Pop-up window is displayed.	–
	1. Help Key Mode	Select this option to set up for Help Key Mode (1 SubMenu/2 Popup Window).	SubMenu
	0 Setting Reset	Select this option to reset the telephone settings.	–
	2 Download	Set the data required when downloading a file.	–
	1 Download Files	Select this option to download files for Music on Hold, ringer tone, Directory and Wallpaper.	–
	1 Hold Music	Select this option to download a file for Music on Hold.	MOH.wav
	2 Ring Tone	Select this option to download files for ringer tones (Download 1 to 3).	–
	1 Music Ring 1	Select this option to download a file for ringer tone (Download 1).	Melody1.wav
	2 Music Ring 2	Select this option to download a file for ringer tone (Download 2).	Melody2.wav
	3 Music Ring 3	Select this option to download a file for ringer tone (Download 3).	Melody3.wav
	3 Directory	Select this option to download the directory files.	Directory.csv
	2 Download Address	Select this option to enter an IP address of the FTP/TFTP/HTTPS server.	0.0.0.0
	3 Protocol	Select this option to specify a protocol of the server (either FTP or TFTP or HTTPS).	FTP
	4 Account Settings	Select this option to set necessary data when using FTP or HTTPS service.	–
	1 User ID	Select this option to enter a user ID for downloading via FTP or HTTPS server.	–
	2 Password	Select this option to enter a password for downloading via FTP or HTTPS server.	–
	3 Folder	Select this option to specify the directory where the downloaded file is stored.	–

Menu Item		Description	Default Value
	3 Data Backup/Restore	Select this option to set the data required for a file backup/restore.	–
	1 Data Backup	Select this option to specify the file name to be backed up.	PersonalData.tgz
	2 Data Restore	Select this option to specify the file name to be restored.	PersonalData.tgz
	3 Server Address	Select this option to enter an IP address of the FTP/TFTP/HTTPS server.	0.0.0.0
	4 Protocol	Select this option to select a protocol of the server (either FTP, TFTP or HTTPS).	FTP
	5 Account Settings	Select this option to set necessary data when using FTP or HTTPS server.	–
	1 User ID	Select this option to enter a user ID for the data backup via FTP or HTTPS server.	–
	2 Password	Select this option to enter a password for data backup via FTP or HTTPS server.	–
	3 Folder	Select this option to specify the destination directory of FTP or HTTPS server.	–

This page is for your notes.

# Appendix B. Web Programming

---

Web Programming allows you to configure the terminal settings of DT930 from the PC. A web browser (Internet Explorer, etc.) is used to access Web Programming. It is not necessary to install any special application software onto the PC.

*Note: The DT930 and Web Programming PC need to be connected to the same network. When downloading the files for Music on Hold, Ringer Tone and Directory to the DT930, FTP/TFTP/HTTPS server are required on the network. For details on the FTP/TFTP/HTTPS server, contact to the System Administrator.*

*Note: Terminal settings through Web Programming is available while DT930 is logged into the system.*

## PC Requirements for Web Programming

Items		Operating Conditions
Operating System		Microsoft® Windows® XP/Vista/ Windows® 7
CPU		Comply with conditions for use of Microsoft® Windows or Microsoft® Internet Explorer.
Memory		
Browser		Microsoft® Internet Explorer 6.0 or later
Monitor	[/ITK-24CG-1]	4.3 inch Color (16777216 colors) TFT
Others		Mouse, LAN connection port (RJ-45)

## Login

Follow the steps below to open the Web Programming.

- (1) Start up Internet browser on the PC.
- (2) Enter **IP address** of the target DT930 on the address toolbar and press **Enter** key.
- (3) The Web Programming Login screen is displayed. Enter a user name (type **USER**) and a password (**Note 1**), then click the **OK** button.



**Note:** Enter the same password used when logging into the DT930. "0000" is used as the default password

**Note:** For IP address of the DT930, contact the System Administrator.

**Note:** If the login screen does not appear, check the LAN connection status and entered IP address. If the problem persists, contact the System Administrator.

(4) The Web Programming **Home** screen appears.

- [-] User Settings
  - ± Incoming Call
  - ± Talk
  - ± Display
    - Change Password
  - ± Usability
    - Setting Reset
- [-] Download
  - ± Download Files
    - Download Address
    - Protocol
  - ± Account Settings
- [-] Data Backup/Restore
  - Data Backup
  - Data Restore
  - Server Address
  - Protocol
  - ± Account Settings

Logout

---

Config Ver : D=185

Home > Backup/Restore > Account Settings

Please select the menu.

## Logout

Follow the steps below to exit the Web Programming.

- (1) Click **Logout** button at the lower left of the screen.

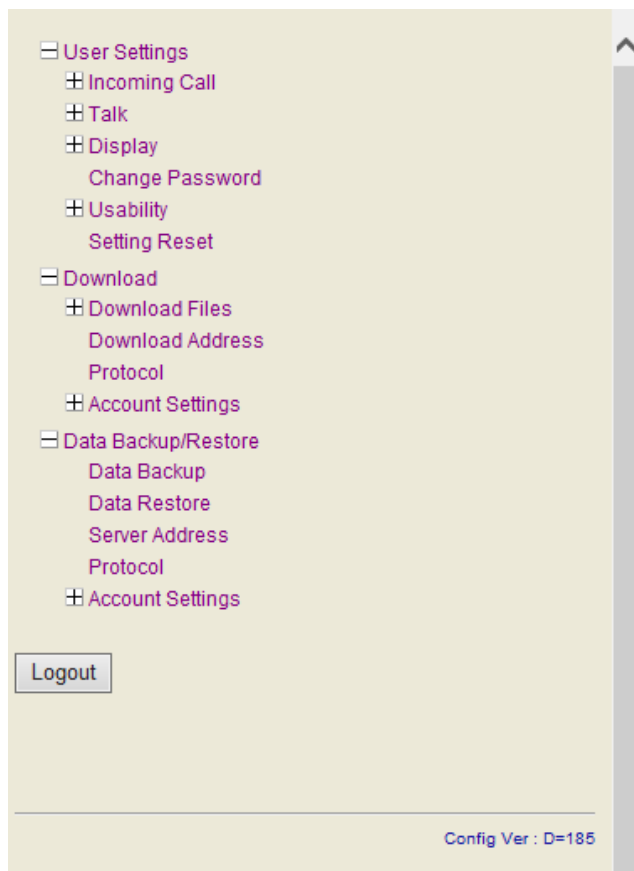

- (2) The confirmation message appears. Click **OK** button to log out of Web Programming.
- (3) The display changes as follows. Click **Back** button.



- (4) After the Web Programming Login screen is displayed, close the Internet browser.

*Note:* Make sure to perform the logout operation after the data setting of the telephone.

*Note:* When 15 minutes have passed leaving the PC without operation after log in to Web Programming, the user is forcibly logged out from the Web Programming.

## How to Operate

The following explains how to change the ringer tone for external call. Web Programming includes the same menu configuration as “Setting” of DT930 terminal. For details on each menu item, see [Setup With Feature Key in 3.TERMINAL SETUP – CLASSIC](#).

- (1) From the Home screen, click **User Setting** → **Incoming Call** → **Ring Tone** → **External Call**.
- (2) Select a desired tone type by clicking the corresponding radio button.
- (3) Click **OK** button to save the change to the database.



Step 1: Click items to navigate through the menu.

Orchestrating a brighter world **NEC**

DT900 Series  
Web Programming  
Hardware Ver 9.1.8.0  
Firmware Ver 92.1.20.0  
MAC Address 8c-e4-da-f1-09-3b

Home > User Settings > Incoming Call > Ring Tone > External Call

External Call

- 0. Automatic
- 1. Tone Type 1
- 2. Tone Type 2
- 3. Tone Type 3
- 4. Tone Type 4
- 5. Tone Type 5
- 6. Tone Type 6
- 7. Tone Type 7
- 8. Tone Type 8
- 9. Tone Type 9
- 10. Tone Type 10
- 11. Tone Type 11
- 12. Tone Type 12
- 13. Tone Type 13
- 14. Tone Type 14
- 15. Music Ring 1
- 16. Music Ring 2
- 17. Music Ring 3

External Call

Cancel **OK**

Logout

Click the Logout Button to exit from Web Programming.

Step 2: Click the OK button to accept the selection.

Step 3: Click the radio button to select a parameter

Config Ver : D=185

- (4) A confirmation dialog appears. Click **OK** button on the dialog.

This page is for your notes.

# Appendix C. To Upload an Image

## Image Upload Procedure

Using the SV9100 User Programming function, you can upload an image related to the Shortcut Icon from your PC.

### PC Connection and Setting

#### PC Requirements

Indicate the conditions of the PC used for User Programming.

OS: Microsoft Windows 8.1 / 10 (32bit and 64bit)

Browser:

- Internet Explorer 7, 8, 9, 10, 11
- Google Chrome v57 or higher
- Microsoft Edge

Other: RJ-45 LAN I/F connector

#### Connection

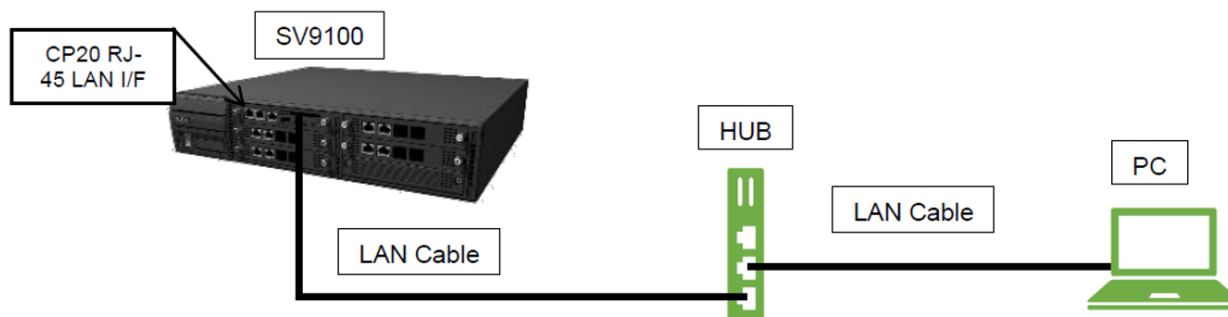

## Maximum User Program PC Connection

You can log in to User Programming on a maximum of 4 PCs at the same time.

## LAN Setting

For details, contact your dealer on how to set up your PC for connecting Web/User Programming to the SV9100 system.

## User Programming Setup

- (1) Open a Web Browser on your PC.
- (2) Enter **https://192.168.0.10** on the URL address area and press the **Enter** key. The following Login menu is displayed.



The screenshot shows a web browser window displaying a login page. The page has a light blue background. In the top left corner, the word "Login" is written in orange. In the top right corner, there is a green checkmark icon above the word "Login". Below this, there are two input fields: "User Name" and "Password". At the bottom right, the UNIVERGE SV9100 logo is displayed.

- (3) Enter **User ID** and **Password**.

The following is the default User ID and Password.

User ID: USER1(NA), user1(other)

Password: 1111

*Note:* Enter User ID and Password using single-byte capital letters.

(4) Press the **Enter** key, the following is displayed.

The screenshot displays a user programming interface with the following sections:

- Home**  
User Programming : 10.00.00 (NEC)
- Settings**
  - Time and Date Setup
  - Music On Hold
  - Automatic Night Mode Switching Setting
  - DISA User ID Setup
  - InMail Mailbox Options
  - Selectable Display Messages
  - Incoming Ring Group Extension
  - Speed Dialing Number and Name
  - Night Mode Switching (Another Group)
  - DSS Key Assignment
  - Doorphone Ringing Assignment
  - Dial-in Name
  - Telephone Setting
  - Trunk Setting
  - UC User Information Setting
  - Multi-Device Group Setup
- Programming**
  - Copy
- Other**
  - VRS Audio Up/Down load
  - InMail Audio Up/Down load (Station)
  - InMail Audio Up/Down load (Group)
  - InMail Audio Up/Down load (Routing)
  - InUC Update
  - Certificate Registration
  - Help
  - Logout

## **To Upload an Image**

The following are specifications for uploading an image:

- Physical phone Extension users are target for photo image except Virtual Extension.
- A maximum of 896 images can be uploaded to the SV9100 system.
- After uploading an image to the SV9100 system, the SV9100 system will automatically download the image to each DT900 terminal.
- Save the images to be uploaded in advance.
- Image file(s) should be in a .jpg format.
- The SV9100 resizes the image file to a certain size. There is no requirement for file size.

(1) From the Home screen, click on **Telephone Setting**.

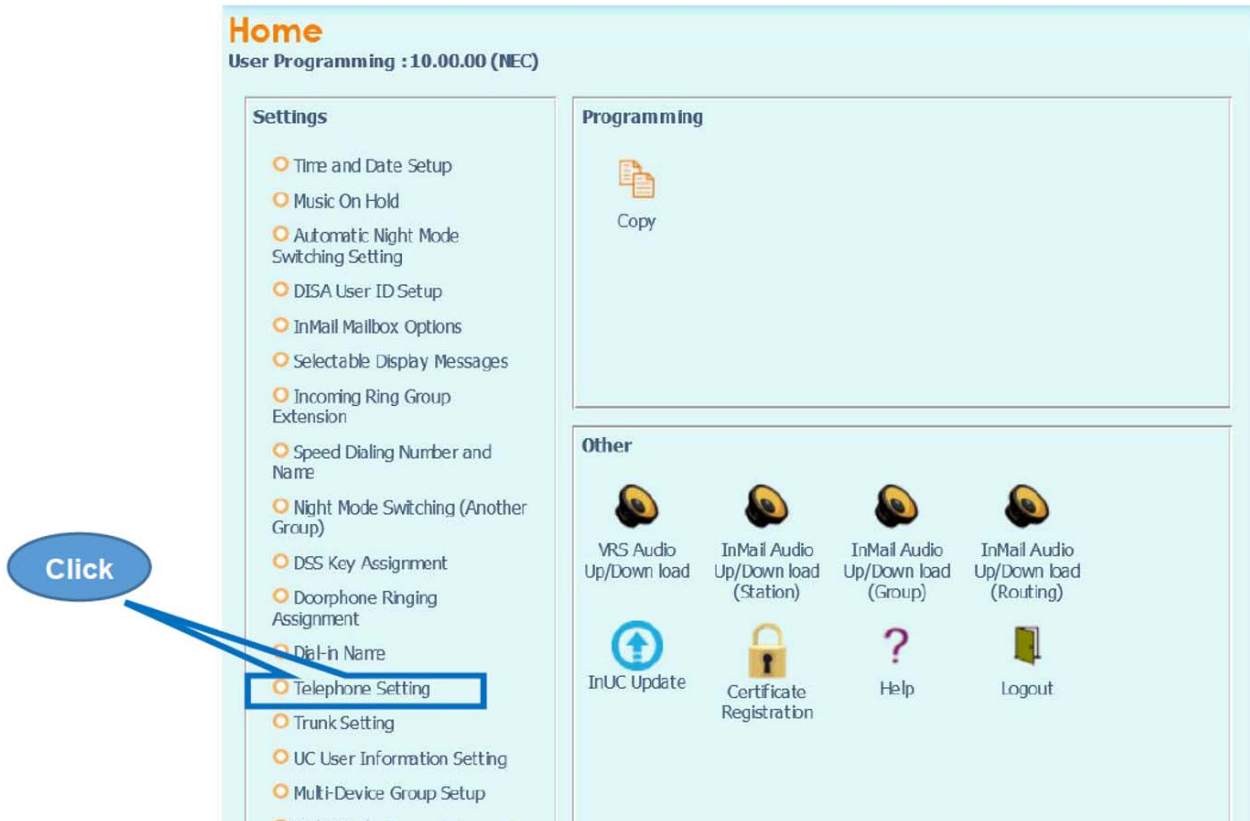

- (2) In the Telephone Setting screen, click on the **Details** icon for the extension you want to upload an image to on the SV9100. In the example shown, 101 is the target extension.

**Telephone Setting**

Apply Refresh Cancel Home

Port (1-960)

Extension Number

Port	Extension	Terminal Type	Terminal Connection Status	IP Address	Availability of 1st Party CTI connection	Call Forward Type - Both Ring/All Call/No Answer	Call Forward Type - Busy	Call Forward Type - Follow-Me	Do Not Disturb	Details
001	<input type="text" value="101"/>	MLT	Available	0.0.0.0	Not Available	Call Forward off	Call Forward off	Disable	No setting	
002	<input type="text" value="201"/>	Not set	Not Available	0.0.0.0	Not Available	Call Forward off	Call Forward off	Disable	No setting	
003	<input type="text" value="202"/>	Not set	Not Available	0.0.0.0	Not Available	Call Forward off	Call Forward off	Disable	No setting	
004	<input type="text" value="203"/>	Not set	Not Available	0.0.0.0	Not Available	Call Forward off	Call Forward off	Disable	No setting	
005	<input type="text" value="204"/>	MLT	Available	0.0.0.0	Not Available	Call Forward off	Call Forward off	Disable	No setting	
006	<input type="text" value="205"/>	Not set	Not Available	0.0.0.0	Not Available	Call Forward off	Call Forward off	Disable	No setting	
007	<input type="text" value="206"/>	Not set	Not Available	0.0.0.0	Not Available	Call Forward off	Call Forward off	Disable	No setting	
008	<input type="text" value="207"/>	Not set	Not Available	0.0.0.0	Not Available	Call Forward off	Call Forward off	Disable	No setting	
009	<input type="text" value="208"/>	Not set	Not Available	0.0.0.0	Not Available	Call Forward off	Call Forward off	Disable	No setting	
010	<input type="text" value="209"/>	Not set	Not Available	0.0.0.0	Not Available	Call Forward off	Call Forward off	Disable	No setting	
011	<input type="text" value="210"/>	Not set	Not Available	0.0.0.0	Not Available	Call Forward off	Call Forward off	Disable	No setting	

**Click**



- (3) From the screen below, use the steps outlined to specify the image to be uploaded.
1. Specify the image file to be uploaded.
  2. Click on the upload icon.
  3. Preview the image.

To delete the uploaded image, click the **Delete** icon.

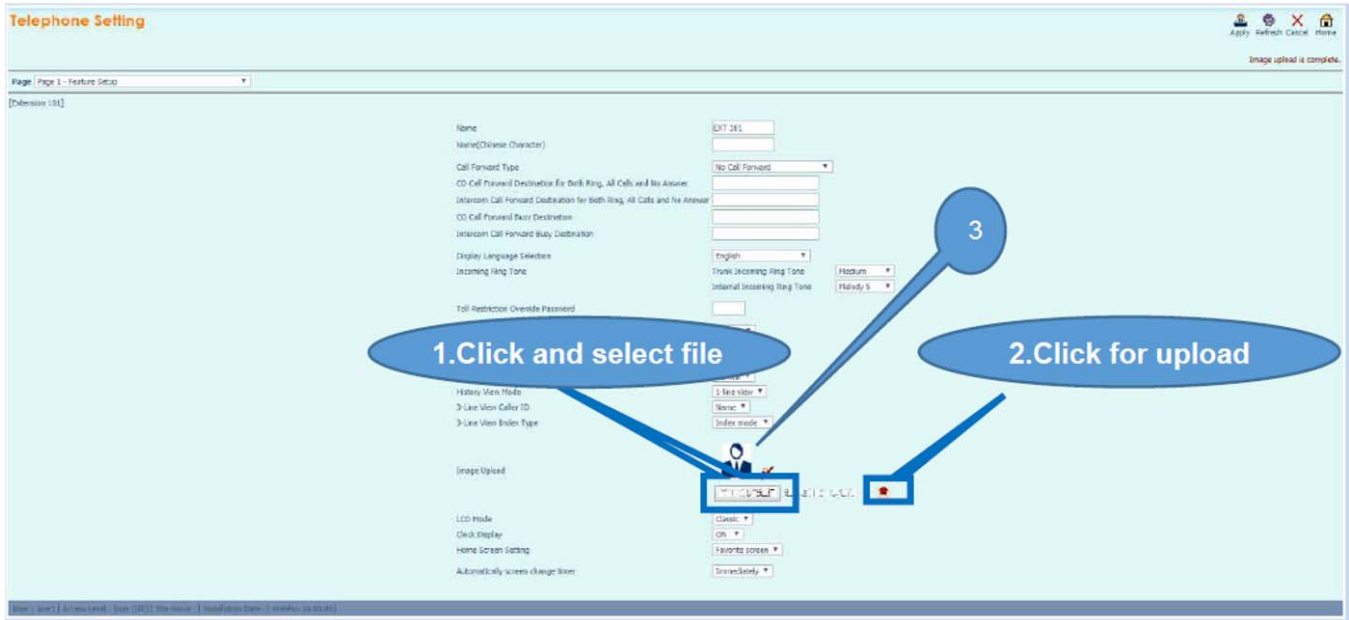

*Note:* When upload is successful, "Image upload is complete." is displayed in the top right corner of the screen.

(4) To upload an image from another extension, click **Cancel** and repeat from step 2 above.

The screenshot displays the 'Telephone Setting' web interface. The page title is 'Telephone Setting'. At the top right, there are navigation icons for 'Home', 'Back', 'Cancel', and 'Print'. Below the title bar, there is a breadcrumb trail: 'Home > Page 3 - Feature Setup'. The main content area is titled '(Extension: 101)'. It contains a list of settings on the left and their corresponding input fields on the right. The 'Image Upload' section is highlighted, showing a 'Cancel' button in a red box. A blue arrow points from a 'Click' callout bubble to the 'Cancel' button. The 'Image Upload' section includes a 'Class' dropdown menu, a 'Class' dropdown menu, a 'Favorite screen' dropdown menu, and an 'Immediately' dropdown menu. The 'Image Upload' section also includes a 'Class' dropdown menu, a 'Class' dropdown menu, a 'Favorite screen' dropdown menu, and an 'Immediately' dropdown menu.

Setting	Value
Name	EXT 101
Name (Character)	
Call Forward Type	No Call Forward
CO Call Forward Destination for Both Ring, All Calls and No Answer	
Intercom Call Forward Destination for Both Ring, All Calls and No Answer	
CO Call Forward Busy Destination	
Intercom Call Forward Busy Destination	
Display Language Selection	English
Incoming Ring Time	Three Incoming Ring Time
Internal Incoming Ring Time	Medium
Talk Extension Operator Password	
Right Mode Switching	Mode 2
End User Password	3333
Text Key Lock/Control	Normal
History View Mode	1-Line view
3-Line View Caller ID	Name
3-Line View Index Type	Index mode
Image Upload	Cancel
LCD Mode	Class
Clock Display	On
Home Screen Setting	Favorite screen
Automatically screen change timer	Immediately

(5) When image upload is complete, click **Home** to exit the Telephone Setting screen.

Telephone Setting

Apply Refresh Cancel Home

Image upload is complete.

Page: Page 3 - Feature Setup

System 1012

Name PST 101

Name(Chinese Character)

Call Forward Type No Call Forward

CO Call Forward Destination for both Ring, All Calls and No Answer

Intercom Call Forward Destination for both Ring, All Calls and No Answer

CO Call Forward Busy Destination

Extension Call Forward Busy Destination

Display Language Selection English

Incoming Ring Tone Trunk Incoming Ring Tone Ringtone

Internal Incoming Ring Tone Internal Incoming Ring Tone Ringtone

Tot Distribution Over/Under Allocation

Night Wake Switching Mode 2

Ext User Password 1111

Two Key Backlight Control Normal

Mobile Video Player 3 Star Video

3-Line Video Call ID Normal

3-Line Video Index Type Indiv. mode

Image Upload

Remove X

Photo Library Camera

Remove Crop Photo Library Camera

LED Mode

Click Display

Home Screen Setting

Automatically screen change timer Immediately

© 2012 ZTE Corporation. All Rights Reserved. ZTE Mobile Phone. | Version: 1.0.0.0.0.0

(6) From the Home screen, click the **Logout** icon to log out.

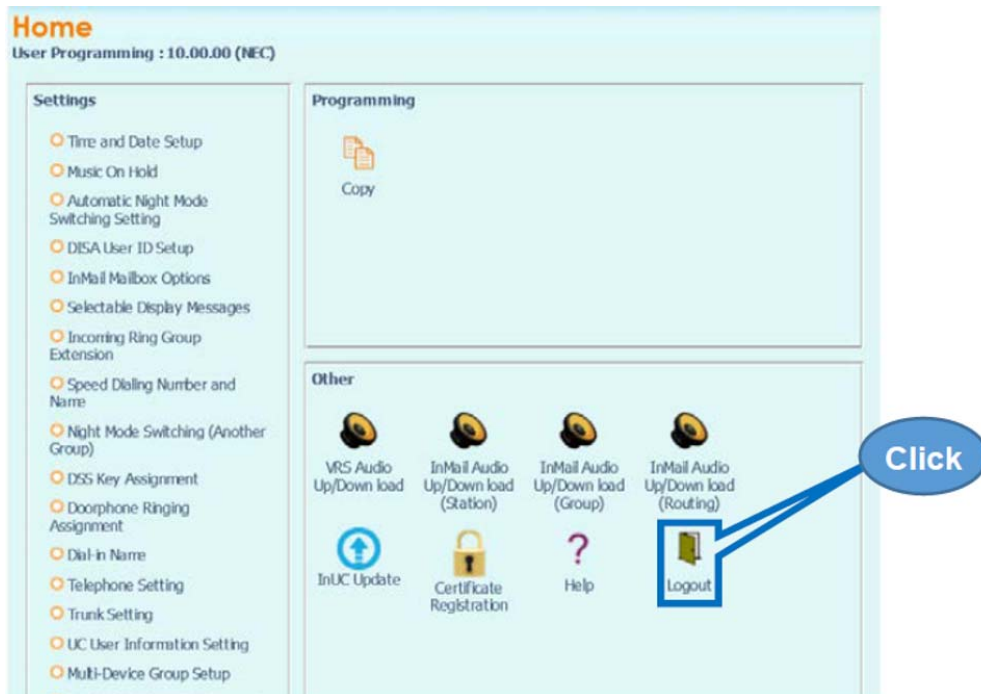



***UNIVERGE<sup>®</sup> SV9100***  
***DT930 (ITK-24CG)***  
***User Guide***

*NEC Enterprise Communication Technologies, Inc.*  
*December, 2019*